

OPERATION AND SERVICE MANUAL

Hypot® III

**MODEL 3605 (AC ONLY HIPOT WITH GROUND CONTINUITY CHECK)
MODEL 3665 (AC/DC HIPOT WITH GROUND CONTINUITY CHECK)
MODEL 3670 (AC/DC HIPOT WITH IR AND GROUND CONTINUITY)**

SERIAL NUMBER

--	--	--	--	--	--	--

Models
3605/3665/3670

© Associated Research, Inc., 2002
13860 West Laurel Drive
Lake Forest, Illinois, 60045-4546
U.S.A.

Item 38302

Ver 1.08

Printed Aug 21, 2002



DECLARATION OF CONFORMITY

Manufacturer: Associated Research, Inc.
Address: 13860 W. Laurel Dr.
Lake Forest, IL 60045
USA
Product Name: Hypot® III Dielectric Withstand
Voltage Tester
Model Number: 3605/3665/3670

Conforms to the following Standards:

Safety: IEC 61010-1: 1993 + A2

EMC: EN 61326: 1997 + A1: 1998 Class A
EN 61000-4-2: 1995, EN 61000-4-3: 1996,
EN 61000-4-4: 1995, EN 61000-4-5: 1995,
EN 61000-4-6: 1996, EN 61000-4-8: 1993,
EN 61000-4-11: 1994.

Supplementary Information

*The product herewith complies with the requirements of the **Low Voltage Directive 73/23/EEC as amended by 93/68/EEC** and the **EMC Directive 89/336/EEC as amended by 92/31/EEC**.*

The CE marking has been affixed on the device according to article 10 of the EMC Directive 8/336/EEC.

The technical file and other documentation are on file with Associated Research, Inc.

Joseph Guerriero
Vice President / General Manager

Associated Research, Inc.
Lake Forest, Illinois USA
April 3, 2002

TABLE OF CONTENTS

1. Introduction.....	1
1.1. Warranty.....	1
1.2. Safety Symbols	2
1.2.1. Product Marking Symbols	2
1.2.2. Caution and Warning Symbols	2
1.3. Glossary of Terms.....	3
1.4. Safety.....	4
1.4.1. Service and Maintenance	4
1.4.2. Test Station	5
1.4.3. Test Operator.....	6
1.4.4. Instrument Connections	6
1.4.5. Device Under Test.....	6
1.4.6. Key Safety Points to Remember	7
1.5. Introduction to Product Safety Testing	8
1.5.1. The Importance of Safety Testing.....	8
1.6. The Different Types of Safety Tests	8
1.6.1. Principles and Uses of Dielectric Withstand Testing	8
1.6.2. Insulation Resistance Test	11
1.6.3. Ground Bond Test	11
1.6.4. Run Test.....	12
1.6.5. Line Leakage Test	12
1.7. Key Features and Benefits.....	14
2. Getting Started	17
2.1. Unpacking and Inspection	17
2.1.1. Packaging.....	17
2.1.2. Contents of Carton.....	17
2.1.3. Returning the Instrument for Service or Calibration.....	17
2.2. Installation	18
2.2.1. Work Area.....	18
2.2.2. Power Requirements.....	18
2.2.3. Basic Connections	18
2.2.4. Environmental Conditions	19
3. Specifications and Controls.....	20
3.1. Specifications.....	20
3.2. Instrument Controls.....	24
3.2.1. Front Panel Controls.....	24
3.2.2. Rear Panel Controls	25
3.3. Quickstart	26

4. Programming Instructions	29
4.1. Setup System	29
4.1.1. Setup System Soft keys	30
4.1.2. System Parameters	30
4.2. Setting up Tests.....	36
4.2.1. Reviewing Test parameters.....	36
4.2.2. Editing Test Parameters.....	37
4.2.3. Reviewing Test Results	37
4.3. Test Parameters.....	37
4.3.1. AC Withstand.....	39
4.3.2. DC Withstand (Models 3665 and 3670).....	40
4.3.3. Insulation Resistance (Model 3670 only)	41
4.3.4. Default Parameters	42
5. Operating Instructions	43
5.1. Instrument Connections.....	43
5.1.1. Adapter Box Connections	43
5.2. Perform Tests, Main Menu, and Results Screens	43
5.2.1. Connected Step Indicator.....	44
5.2.2. Main Menu.....	44
5.2.3. Results, Tests and System Selections	45
5.3. Perform Tests Metering.....	46
5.4. Performing a Test.....	46
6. Instrument Verification	49
6.1. Verification Initialization	49
6.2. Verification Menu.....	49
6.2.1. Continuity Verification.....	50
6.2.2. AC Hipot Verification	51
6.2.3. DC Hipot Verification	52
6.2.4. IR Verification	53
7. Remote Control	54
7.1. Signal Outputs on Remote I/O.....	54
7.2. Signal Inputs of Remote I/O and Memory Access	55
8. Options	58
9. Calibration Procedure	60
9.1. Warranty Requirements.....	60
9.2. Calibration Initialization	61
9.2.1. Calibration of Parameters	61
10. Replacement Parts List	65
11. Schematic Index	66
12. Index	67

1. Introduction

1.1. 5 Year Warranty Policy

Associated Research, Inc., certifies that the instrument listed in this manual meets or exceeds published manufacturing specifications. This instrument was calibrated using standards that are traceable to the National Institute of Standards and Technology (NIST).

Your new instrument is warranted to be free from defects in workmanship and material for a period of (1) year from date of shipment. You must return the “Owners Registration Card” provided within (15) days from receipt of your instrument.

AR recommends that your instrument be calibrated on a twelve-month cycle. Instruments purchased and used in North America only, may have their warranty extended in one year increments to a maximum of **(5) years** provided they are returned to AR at least **annually** for calibration and inspection. The annual calibration and inspection must be performed annually every year following receipt of instrument. Any instrument not calibrated and inspected annually will not be eligible for extended warranty status. This extended warranty is non-transferable and is offered only to the original purchaser. A return material authorization (RMA) must be obtained from AR before returning this instrument for warranty service. Please contact our Customer Support Center at 1-800-858-TEST (8378) to obtain an RMA number. It is important that the instrument is packed in its original container for safe transport. If the original container is not available please contact our customer support center for proper instructions on packaging. Damages sustained as a result of improper packaging will not be honored. Transportation costs for the return of the instrument for warranty service must be prepaid by the customer. AR will assume the return freight costs when returning the instrument to the customer. The return method will be at the discretion of Associated Research.

Except as provided herein, Associated Research makes no warranties to the purchaser of this instrument and all other warranties, express or implied (including, without limitation, merchantability or fitness for a particular purpose) are hereby excluded, disclaimed and waived.

Any non-authorized modifications, tampering or physical damage will void your warranty. Elimination of any connections in the earth grounding system or bypassing any safety systems will void this warranty. This warranty does not cover batteries or accessories not of Associated Research manufacture. Parts used must be parts that are recommended by AR as an acceptable specified part. Use of non-authorized parts in the repair of this instrument will void the warranty.

1.2. Safety Symbols

1.2.1. Product Marking Symbols



Product will be marked with this symbol when it is necessary to refer to the operation and service manual in order to prevent injury or equipment damage.



Product will be marked with this symbol when hazardous voltages may be present.



Product will be marked with this symbol at connections that require earth grounding.

1.2.2. Caution and Warning Symbols



Calls attention to a procedure, practice, or condition that could possibly cause bodily injury or death.



Calls attention to a procedure, practice, or condition that could possibly cause damage to equipment or permanent loss of data

1.3. Glossary of Terms

(As used in this manual)

Alternating Current, AC: Current that reverses direction on a regular basis, commonly in the U.S.A. 60 per second, in other countries 50 times per second.

Breakdown: The failure of insulation to effectively prevent the flow of current sometimes evidenced by arcing. If voltage is gradually raised, breakdown will begin suddenly at a certain voltage level. Current flow is not directly proportional to voltage. Once breakdown current has flown, especially for a period of time, the next gradual application of voltage will often show breakdown beginning at a lower voltage than initially.

Conductive: Having a volume resistivity of no more than 10^3 ohm-cm or a surface resistivity of no more than 10^5 ohms per square.

Conductor: A solid or liquid material which has the ability to let current pass through it, and which has a volume resistivity of no more than 10^3 ohm-cm.

Current: The movement of electrons through a conductor. Current is measured in amperes, milliamperes, microamperes, nanoamperes, or picoamperes. Symbol = **I**

Dielectric: An insulating material that is positioned between two conductive materials in such a way that a charge or voltage may appear across the two conductive materials.

Direct Current, DC: Current that flows in one direction only. The source of direct current is said to be polarized and has one terminal that is always at a higher potential than the other.

Hipot Tester: Common term for dielectric-withstand test equipment.

Hypot®: Registered trademark of Associated Research, Inc., for its dielectric-withstand test equipment.

Insulation: Gas, liquid or solid material which has a volume resistivity of at least 10^{12} ohm-cm and is used for the purpose of resisting current flow between conductors.

Insulation Resistance Tester: An instrument or a function of an instrument capable of measuring resistance's in excess of 200 megohms. Usually employs a higher voltage power supply than used in ohmmeters measuring up to 200 megohms.

Leakage: AC or DC current flow through insulation and over its surfaces, and AC current flow through a capacitance. Current flow is directly proportional to voltage. The insulation and/or capacitance is thought of as a constant impedance, unless breakdown occurs.

Resistance: That property of a substance that impedes current and results in the dissipation of power, in the form of heat. The practical unit of resistance is the *ohm*. Symbol = **R**

Trip Point: A minimum or maximum parameter set point that will cause an indication of unacceptable performance during a run test.

Voltage: Electrical pressure, the force which causes current through an electrical conductor.
Symbol = **V**

1.4. Safety

This product and its related documentation must be reviewed for familiarization with safety markings and instructions before operation.

This product is a Safety Class I instrument (provided with a protective earth terminal). Before applying power verify that the instrument is set to the correct line voltage (110 or 220) and the correct fuse is installed.

WARNING

A Hipot produces voltages and currents that can cause **harmful or fatal electric shock**. To prevent accidental injury or death, these safety procedures must be strictly observed when handling and using the test instrument.

1.4.1. Service and Maintenance

User Service

To prevent electric shock do not remove the instrument cover. There are no user serviceable parts inside. Routine maintenance or cleaning of internal parts is not necessary. Avoid the use of cleaning agents or chemicals on the instrument, some chemicals may damage plastic parts or lettering. Any external cleaning should be done with a clean dry or slightly damp cloth. Schematics, when provided, are for reference only. Any replacement cables and high voltage components should be acquired directly from Associated Research, Inc. Refer servicing to an Associated Research, Inc. authorized service center.

ASSOCIATED RESEARCH, INC.
13860 WEST LAUREL DRIVE
LAKE FOREST, IL 60045-4546 U.S.A.

PHONE: 1 (847) 367-4077
1 (800) 858-TEST (8378)
FAX: 1 (847) 367-4080
E-MAIL : info@asresearch.com
www.asresearch.com

Service Interval

The instrument, its power cord, test leads, and accessories must be returned at least once a year to an Associated Research authorized service center for calibration and inspection of safety related components. Associated Research will not be held liable for injuries suffered if the instrument is not properly maintained and safety checked annually.

User Modifications

Unauthorized user modifications will void your warranty. Associated Research will not be responsible for any injuries sustained due to unauthorized equipment modifications or use of parts not specified by Associated Research. Instruments returned to Associated Research with unsafe modifications will be returned to their original operating condition at the customers expense.

1.4.2. Test Station

Location

Select an area away from the main stream of activity which employees do not walk through in performing their normal duties. If this is not practical because of production line flow, then the area should be roped off and marked for **HIGH VOLTAGE TESTING**. No employees other than the test operators should be allowed inside.

If benches are placed back-to-back, be especially careful about the use of the bench opposite the test station. Signs should be posted: **"DANGER - HIGH VOLTAGE TEST IN PROGRESS - UNAUTHORIZED PERSONNEL KEEP AWAY."**

Work Area

Perform the tests on a non-conducting table or workbench, if possible. If you cannot avoid using a conductive surface, be certain that it is connected to a good earth ground and the high voltage connection is insulated from the grounded surface.

There should not be any metal in the work area between the operator and the location where products being tested will be positioned. Any other metal in the work area should be connected to a good ground, never left "floating".

Position the tester so the operator does not have to reach over the product under test to activate or adjust the tester. If the product or component being tested is small, it may be possible to construct guards or an enclosure around the device to be tested. Construct the guards of a non-conducting material such as clear acrylic, so that the item being tested is within the guards or enclosure during the test. If possible, the guards or enclosure should also contain safety switches that will not allow the tester to operate unless the guards are in place or the enclosure closed.

Keep the area clean and uncluttered. All test equipment and test leads not necessary for the test should be removed from the test bench and put away. It should be apparent to both the operator and to any observers, the product that is being tested and the product that is waiting to be tested, or has already been tested.

Do not perform Hipot tests in a combustible atmosphere or in any area where combustible materials are present.

Power

Dielectric Voltage-Withstand Test Equipment must be connected to a good ground. Be certain that the power wiring to the test bench is properly polarized and that the proper low resistance bonding to ground is in place.

Power to the test station should be arranged so that it can be shut off by one prominently marked switch located at the entrance to the test area. In case of an emergency, anyone can cut off the power before entering the test area to offer assistance.

1.4.3. Test Operator

Qualifications

This instrument generates voltages and currents that can cause **harmful or fatal electric shock** and must only be operated by a skilled worker trained in its use.

The operator should understand the electrical fundamentals of voltage, current, and resistance. They should recognize that the test instrument is a variable high-voltage power supply with the return circuit directly connected to earth ground, therefore, current from the high-voltage output will flow through any available ground path.

Rules

Operators should be thoroughly trained to follow all of the aforementioned rules, in addition to any other applicable safety rules and procedures. Defeating any safety system should be considered a serious offense with severe penalties such as removal from the Hipot testing job. Allowing unauthorized personnel in the area during a test should also be dealt with as a serious offense.

Dress

Operators should not wear jewelry that could accidentally complete a circuit.

Medical Restrictions

Personnel with heart ailments or devices such as pacemakers should be informed that the voltages and currents generated by the instrument are very dangerous. If contacted it may cause heart-related problems that a person of good health may not experience. Please have the test operator consult their physician for recommendations.

1.4.4. Instrument Connections

WARNING Never perform a hipot test on energized circuitry or equipment.



The instrument is equipped with a safety ground connection, be sure that this is connected to a good earth ground.

Always connect the return lead first, regardless of whether the item under test is a sample of insulating material, a component tested with the high voltage test lead, or a cord-connected device with a two or three prong plug. The return lead should be connected first for any type of hipot testing.

Plug in the high voltage test lead only when it is being used. Handle its clip only by the insulator---**never touch the clip directly**. Be certain that the operator has control over any remote test switches connected to the Hipot. Double check the return and high voltage connections from the Hipot and the Line, Neutral, Ground and Case connections from the Line Leakage tester to be certain that they are proper and secure.

1.4.5. Device Under Test

WARNING

Never touch the Device Under Test (DUT) or anything connected to it while high voltage is being applied by the hipot.

When testing with DC, always discharge the capacitance of the item under test and anything the high voltage may have contacted--such as test fixtures--before handling it or disconnecting the test leads.

HOT STICK probes can be used to discharge any capacitance in the device under test as a further safety precaution. A hot stick is a non-conducting rod about two feet long with a metal probe at the end that is connected to a wire. To discharge the device under test, two hot sticks are required. First, connect both probe wires to a good earth ground. Then touch one probe tip to the same place that the return lead was connected. While holding the first probe in place, touch the second probe tip to the same place where the high voltage lead was connected.

1.4.6. Key Safety Points to Remember

- Keep unqualified and unauthorized personnel away from the test area.
- Arrange the test station in a safe and orderly manner.
- Never touch the product or connections during a test.
- In case of any problem, turn off the high voltage first.
- Properly discharge any item tested with DC before touching connections.

1.5. Introduction to Product Safety Testing

1.5.1. The Importance of Safety Testing

Product Safety Tests are specified during the design and development stages of a product as well as in the production of the products to insure that it meets basic safety requirements. These tests are designed to verify the safety of the electrical products in that they do not jeopardize the safety of the people, domestic animals, and property of anyone who may come in contact with these products. In an era of soaring liability costs, original manufacturers of electrical and electronic products must make sure every item is as safe as possible. All products must be designed and built to prevent electric shock, even when users abuse the equipment or by-pass built in safety features.

To meet recognized safety standards, one common test is the "dielectric voltage-withstand test". Safety agencies which require compliance safety testing at both the initial product design stage and for routine production line testing include: Underwriters Laboratories, Inc. (UL), the Canadian Standards Association (CSA), the International Electrotechnical Commission (IEC), the British Standards Institution (BSI), the Association of German Electrical Engineers (VDE) and (TÜV), the Japanese Standards Association (JSI). These same agencies may also require that an insulation resistance test and high current ground bond test be performed.

1.6. The Different Types of Safety Tests

1.6.1. Dielectric Withstand Test

The principle behind a dielectric voltage - withstand test is simple. If a product will function when exposed to extremely adverse conditions, it can be assumed that the product will function in normal operating circumstances.

Common Applications of the Dielectric Withstand Test:

- Design (performance) testing: Determining design adequacy to meet service conditions.
- Production Line testing: Detecting defects in material or workmanship during processing.
- Acceptance testing: Proving minimum insulation requirements of purchased parts.
- Repair Service testing: Determine reliability and safety of equipment repairs.

The specific technique used to apply the dielectric voltage - withstand test to each product is different. During a dielectric voltage - withstand test, an electrical device is exposed to a voltage significantly higher than it normally encounters, for a specified duration of time.

During the test, all current flow from the high voltage output to the return is measured. If, during the time the component is tested, the current flow remains within specified limits, the device is assumed safe under normal conditions. The basic product design and use of the insulating material will protect the user against electrical shock.

The equipment used for this test, a dielectric-withstand tester, is often called a "hipot" (for high potential tester). The "rule of thumb" for testing is to subject the product to twice its normal operating voltage, plus 1,000 volts.

However, specific products may be tested at much higher voltages than 2X operating voltages + 1,000 volts. For example, a product designed to operate in the range between 100 to 240 volts can be tested between 1,000 to 4,000 volts or higher. Most "double insulated" products are tested at voltages much higher than the "rule of thumb".

Testing during development and prototype stages is more stringent than production run tests because the basic design of the product is being evaluated. Design tests usually are performed on only a few samples of the product. Production tests are performed on every item as it comes off the production line.

The hipot tester must also maintain an output voltage between 100% and 120% of specification. The output voltage of the hipot must have a sinusoidal waveform with a frequency between 40 to 70 Hz and has a peak waveform value that is not less than 1.3 and not more than 1.5 times the root-mean-square value.

Types of Failures only detectable with a Hipot test

- Weak Insulating Materials
- Pinholes in Insulation
- Inadequate Spacing of Components
- Pinched Insulation

Dielectric Withstand Test; AC versus DC

Please check with the Compliance Agency you are working with to see which of the two types of voltages you are authorized to use. In some cases, a Compliance Agency will allow either AC or DC testing to be done. However, in other cases the Compliance Agency only allows for an AC test. If you are unsure which specification you must comply with please contact our CUSTOMER SUPPORT GROUP at 1-800-858-TEST (8378).

Many safety agency specifications allow either AC or DC voltages to be used during the hipot test. When this is the case, the manufacturer must make the decision on which type of voltage to utilize. In order to do this it is important to understand the advantages and the disadvantages of both AC and DC testing.

AC testing characteristics

Most items that are hipot tested have some amount of distributed capacitance. An AC voltage cannot charge this capacitance so it continually reads the reactive current that flows when AC is applied to a capacitive load.

AC testing advantages

AC testing is generally much more accepted by safety agencies than DC testing. The main reason for this is that most items being hipot tested will operate on AC voltages. AC hipot testing offers the advantage of stressing the insulation alternately in both polarities, which more closely simulates stresses the product will see in real use.

Since AC testing cannot charge a capacitive load the current reading remains consistent from initial application of the voltage to the end of the test. Therefore, there is no need to gradually bring up the voltage since there is no stabilization required to monitor the current reading. This means that unless the product is sensitive to a sudden application of voltage the operator can immediately apply full voltage and read current without any wait time.

Another advantage of AC testing is that since AC voltage cannot charge a load there is no need to discharge the item under test after the test.

AC testing disadvantages

One disadvantage of AC testing surfaces when testing capacitive products. Again, since AC cannot charge the item under test, reactive current is constantly flowing. In many cases, the reactive component of the current can be much greater than the real component due to actual leakage. This can make it very difficult to detect products that have excessively high leakage current.

Another disadvantage of AC testing is that the hipot has to have the capability of supplying reactive and leakage current continuously. This may require a current output that is actually much higher than is really required to monitor leakage current and in most cases is usually much higher than would be needed with DC testing. This can present increased safety risks as operators are exposed to higher currents.

DC testing characteristics

During DC hipot testing the item under test is charged. The same test item capacitance that causes reactive current in AC testing results in initial charging current which exponentially drops to zero in DC testing.

DC testing advantages

Once the item under test is fully charged, the only current flowing is true leakage current. This allows a DC hipot tester to clearly display only the true leakage of the product under test.

Another advantage to DC testing is that the charging current only needs to be applied momentarily. This means that the output power requirements of the DC hipot tester can typically be much less than what would be required in an AC tester to test the same product.

DC testing disadvantages

Unless the item being tested has virtually no capacitance, it is necessary to raise the voltage gradually from zero to the full test voltage. The more capacitive the item the more slowly the voltage must be raised. This is important since most DC hipots have failure shut off circuitry

which will indicate failure almost immediately if the total current reaches the leakage threshold during the initial charging of the product under test.

Since a DC hipot does charge the item under test, it becomes necessary to discharge the item after the test.

DC testing unlike AC testing only charges the insulation in one polarity. This becomes a concern when testing products that will actually be used at AC voltages. This is an important reason that some safety agencies do not accept DC testing as an alternative to AC.

When performing AC hipot tests the product under test is actually tested with peak voltages that the hipot meter does not display. This is not the case with DC testing since a sinewave is not generated when testing with direct current. In order to compensate for this most safety agencies require that the equivalent DC test be performed at higher voltages than the AC test. The multiplying factor is somewhat inconsistent between agencies which can cause confusion concerning exactly what equivalent DC test voltage is appropriate.

1.6.2. Insulation Resistance Test

Some "dielectric analyzers today come with a built in insulation resistance tester. Typically, the IR function provides test voltages from 500 to 1,000 volts DC and resistance ranges from kilohms to gigaohms. This function allows manufacturers to comply with special compliance regulations. BABT, TÜV and VDE are agencies that may under certain conditions, require an IR test on the product before a Hipot test is performed. This typically is not a production line test but a performance design test.

The insulation resistance test is very similar to the hipot test. Instead of the go/no go indication that you get with a hipot test the IR test gives you an insulation value usually in Megohms. Typically, the higher the insulation resistance value the better the condition of the insulation. The connections to perform the IR test are the same as the hipot test. The measured value represents the equivalent resistance of all the insulation which exists between the two points and any component resistance which might also be connected between the two points.

Although the IR test can be a predictor of insulation condition it does not replace the need to perform a dielectric withstand test.

1.6.3. Ground Bond Test

The Ground Bonding test determines whether the safety ground circuit of the product under test can adequately handle fault current if the product should ever become defective. A low impedance ground system is critical in ensuring that in case of a product failure, a circuit breaker on the input line will act quickly to protect the user from any serious electrical shock.

International compliance agencies such as CSA, IEC, TÜV, VDE, BABT and others, have requirements calling out this test. This test should not be confused with low current continuity tests that are also commonly called out in some safety agency specifications. A low current test merely indicates that there is a safety ground connection. It does not completely test the integrity of that connection.

Compliance agency requirements vary on how different products are to be tested. Most specifications call for test currents of between 10 and 30 amps. Test voltages at these currents are typically required to be less than 12 volts. Maximum allowable resistance readings of the safety ground circuit are normally between 100 and 200 milliohms.

If you are testing a product that is terminated in a three-prong plug, you are required to perform a continuity or ground bond test on the ground conductor to the chassis or dead metal of the product.

1.6.4. Run Test

All manufacturers of a product that runs on line power normally need to run the DUT (Device Under Test) after final safety testing so that they can verify the functionality of their products. In addition to running the DUT to test its basic functionality many customers also require some basic test data to be recorded while the DUT is powered up. A Run Test System allows the product to be powered up immediately after the safety tests are completed with a single connection to the DUT. Measurements that are commonly made while the DUT is running can include Amperage, Voltage, Watts and Power Factor.

1.6.5. Line Leakage Test

The Line Leakage test is one of many product safety tests that are normally specified for electrical products by safety testing agencies such as Underwriters Laboratories (UL) and the International Electrotechnical Committee (IEC). The line leakage specifications vary as well as the method in which the measurements are taken depending upon the application or function of a product and the standard to which the product is being tested.

Current Leakage or Line Leakage tests are general terms that actually describe three different types of tests. These tests are Earth Leakage Current, Enclosure Leakage Current, and Applied Part Leakage Current. The main differences in these tests are in the placement of the probe for the measuring device. The Earth Leakage Current is the leakage current that flows through the ground conductor in the line cord back to earth. The Enclosure Leakage Current is the current that flows from any enclosure part through a person back to ground if it were contacted by a person. The Applied Part Leakage Current or Patient Lead Leakage Current is any leakage that flows from an applied part, between applied parts or into an applied part. The Applied Part Leakage Current test is required only for medical equipment. All of these tests are used to determine if products can be safely operated or handled without posing a shock hazard to the user.

Line Leakage Testers provide the capability of meeting the line leakage test specified in the following standards; UL 544, IEC 950, UL 1950, IEC 601-1, UL 2601, UL 1563, UL 3101, IEC 1010 and others. The Line Leakage test, is a test which measures the leakage current of a product, through a circuit that is designed to simulate the impedance of the human body. The simulation circuit is called the Measuring Device (MD). The instrument has five different MD circuits, selectable through the menu, which are representative circuits designed to simulate the impedance of the human body under different conditions. The impedance of the human body will vary depending upon point of contact, the surface area of the contact and the path the current flows. For these reasons, the specifications of the Measuring Devices are different

depending upon the type of test being performed as well as the maximum allowable leakage current. Leakage current measurements are performed on products under normal conditions and single fault conditions as well as reversed polarity. This simulates possible problems, which could occur if the product under test is faulted or misused while the product is operating under high line conditions (110% of the highest input voltage rating of the product).

Line Leakage tests are normally specified as “Type Tests” or “Design Tests” which are performed during the development of the product. This helps verify that the design is safe but it does not guarantee the safety of the products being produced on the production line. The only way to be sure you are shipping safe products is to test each product at the end of the production line. The user may perform a Leakage Current test along with other common safety test such as Dielectric Withstand, Insulation Resistance, and Ground Bond on the production line with a single connection to the device under test.

IF YOU SHOULD HAVE ANY QUESTIONS RELATING TO THE OPERATION OF YOUR INSTRUMENT CALL 1-800-858-TEST(8378) IN THE U.S.A.

1.7. Key Features and Benefits: HYPOT III

The first manual safety testing instrument with an enhanced graphic LCD display.	<p>This provides the operator with complete test setup and results in an easy-to-use interface. This eliminates the need to decipher cryptic abbreviations. The graphic display makes testing safer, easier and more reliable than ever before.</p>
Exclusive SmartGFI function	<p>The SmartGFI (patent pending) provides maximum operator protection to the user. If the circuit detects excessive leakage to ground, it shuts down the high voltage in less than 1 millisecond. SmartGFI is automatically activated if the DUT is not grounded. The operator does not need to make the decision whether to activate the SmartGFI.</p>
Storage of up to 10 setups with 3 steps per setup	<p>A real benefit for manufacturers that test different products. Each setup can store up to 3 steps, which can be configured to perform any of the safety tests. Tests can be linked and run in any order.</p>
Line and Load regulation	<p>Maintains the output voltage to within 1% of setting even if the load or the line voltage varies. This ensures that the test results remain consistent and within safety agency requirements.</p>
Digitally controlled arc detection system	<p>Allows the operator to select whether low-level arcs should be detected and provides the operator with the ability to digitally select and program multiple sensitivity levels.</p>
No load setup of trip current and output voltage	<p>This provides the operator with an easy and safe way to set trip currents and output voltages since parameters are set without the high voltage activated.</p>
TUV & UL listing	<p>This assures you that this instrument meets or exceeds safety requirements to ensure operator safety.</p>
Automatic storage of test program	<p>Hypot III powers up with the parameters that were used during the last test to avoid operator set-up errors.</p>
All parameters for the setups can be adjusted through a simple menu driven program	<p>The easy to follow setup screens ensure that the operator correctly sets up all test parameters.</p>
Tamper proof front panel controls	<p>This makes it possible to limit user access to the setup screens so that only authorized personnel with a security code can change test parameters.</p>

The Graphic display allows monitoring of current down to 1 microamps AC and DC	This allows the Hypot III to be used even when test requirements only allow a very low level of acceptable leakage current.
Electronic dwell settings	The electronic dwell control helps keep test results consistent by ensuring that the test duration is the same for each product tested.
PLC remote inputs and outputs	The standard 9 pin interfaces provide outputs for Pass, Fail, Reset and Test in Process. Inputs include Test, Interlock and Reset. Remote recall of memory program #1, #2 and #3. This gives the user all the basic remotes required to configure the Hypot III through simple PLC relay control.
Maximum output current 20 milliamps AC and 7.5 milliamps DC	This makes this instrument a true hipot tester with enough output current to test capacitive loads in AC mode and allows the instrument to comply with the UL “120 K ohm” requirements.
Software calibration control	Hypot III is calibrated through the front panel keypad. All calibration information is stored in non-volatile memory. This allows Hypot III to be completely calibrated without removing any covers and exposing the technician to hazardous voltages.
User selectable output voltage frequencies of 50 or 60 hertz	Hypot III was designed for the global market. This feature makes it simple for the user to select the output frequency in the AC hipot mode so that products can be tested at the same frequency they will be used at.
Output voltage fine adjustment	To make Hypot III usable in all types of applications, the operator can manually bring the voltage up or down in 10 volt increments by simply pressing the up and down arrow keys. This makes it very easy to adjust the output voltage even while Hypot III is in the dwell mode so you can analyze test results at different voltages.
Built-in adjustable Continuity test mode	Hypot III meets ground continuity test requirements called out by UL and other safety agencies.
Flashing high voltage indicator	A flashing LED located directly over the high voltage terminal clearly indicates when high voltage is active to provide maximum operator safety.

Comes complete with a test box for products terminated in a line cord	The standard US style receptacle box allows easy testing of hipot and continuity on line cord terminated products. As an additional benefit, termination boxes are available for testing products with line cords configured for other countries.
User selectable input voltage	Hypot III can be switched for either 115 or 230 volt input operation through an easy access rear panel mounted switch to allow it to be used in any country.
Low-current sense	Monitors the minimum level of current flow, thus ensuring that the DUT is properly connected and that the hipot test is being performed.
Electronic ramping (up & down)	Provides a gradual and timed method to increase or decrease output voltage to the DUT, minimizing any damage from quick high voltage changes to sensitive DUTs.

2. Getting Started

Introduction

This section contains information for the unpacking, inspection, preparation for use and storage of your Associated Research, Inc., product.

2.1. Unpacking and Inspection

2.1.1. Packaging

Your instrument was shipped in a custom foam insulated container that complies with ASTM D4169-92a Assurance Level II Distribution Cycle 13 Performance Test Sequence.

If the shipping carton is damaged, inspect the contents for visible damage such as dents, scratches or broken display. If the instrument is damaged, notify the carrier and Associated Research's customer support department. Please save the shipping carton and packing material for the carrier's inspection. Our customer support department will assist you in the repair or replacement of your instrument. Please do not return your product without first notifying us and receiving an RMA (return material authorization) number. To receive an RMA number, please contact our customer support department at (1-800-858-8378).

- Please retain all of the original packaging materials.

2.1.2. Contents of the Carton

Inside the carton should be the following:

Description	AR Part Number
Hypot III Instrument	36XX
High Voltage Cable	04040A-08
Return Cable	02100A-13 (Qty. 2)
Fuse	3.15 Amp, fast acting 250VAC
Line Cord*	33189 Standard
Adapter Box*	38202 Standard

*The Adapter Box and Line Cord listed are American. Other combinations of Line Cord and Adapter Box are available upon request.

2.1.3. Returning the Instrument

When it is necessary to return the instrument for servicing or calibration, repackage the instrument in its original container, please include all accessories and test leads. Indicate the nature of the problem or type of service needed. Also, please mark the container "FRAGILE" to insure proper handling. Upon receipt, your instrument will be issued an AR service number. Please refer to this number in all correspondence.

If you do not have the original packaging materials, please follow these guidelines:

- Wrap the instrument in a bubble pack or similar foam. Enclose the same information as above.

- Use a strong double-wall container that is made for shipping instrumentation. 350-lb. test material is adequate.
- Use a layer of shock-absorbing material 70 to 100 mm (3 to 4 inch) thick around all sides of the instrument. Protect the control panel with cardboard.
- Seal the container securely.
- Mark the container "FRAGILE" to insure proper handling.
- Please refer in all correspondence to your AR service number.

2.2. Installation

2.2.1. Work Area

WARNING Locate a suitable testing area and be sure you have read all safety instructions for the operation of the instrument and suggestions on the test area set-up in the Safety section. Make sure the work area you choose has a three-prong grounded outlet. Be sure the outlet has been tested for proper wiring before connecting the instrument to it.

2.2.2. Power Requirements

This instrument requires a power source of either 115 volts AC \pm 15%, 50/60 Hz single phase or 230 volts AC \pm 15%, 50/60 Hz single phase. Please check the rear panel to be sure the proper switch setting is selected for your line voltage requirements before turning your instrument on. For operation at 115 and 230 Volts AC use a 3.15 Amp, fast acting 250VAC.

CAUTION Do not switch the line voltage selector switch located on the rear panel while the instrument is on or operating. This may cause internal damage and represents a safety risk to the operator.

2.2.3. Basic Connections

Power Cable

WARNING Before connecting power to this instrument, the protective ground (Earth) terminals of this instrument must be connected to the protective conductor of the line (mains) power cord. The main plug shall only be inserted in a socket outlet (receptacle) provided with a protective ground (earth) contact. This protective ground (earth) **must not be defeated** by the use of an extension cord without a protective conductor (grounding).

The instrument is shipped with a three-wire power cable. When the cable is connected to an appropriate AC power source, the cable will connect the chassis to earth ground. The type of power cable shipped with each instrument depends on the country of destination.

Return Connection

CAUTION The output power supplies of this instrument are referenced directly to earth ground. Any conductor that completes a path between the high voltage and earth ground will form a completed circuit.

When the instrument Return is grounded, any internal and external stray leakage will be monitored due to currents that flow from High Voltage to earth ground (such as from HV to the chassis of the instrument). This current is inherent and will cause errors when trying to monitor very low leakage currents in the microamp range.

2.2.4. Environmental Conditions

This instrument may be operated in environments with the following limits:

Temperature..... 32° - 104° F (0° - 40°C)
Relative humidity..... 0 – 80%
Altitude..... 6560 feet (2,000 meters)

Storage and Shipping Environment

This instrument may be stored or shipped in environments with the following limits:

Temperature..... -40° - 167° F (-40° - 75°C)
Altitude..... 50,000 feet (15,240 meters)

The instrument should also be protected against temperature extremes that may cause condensation within the instrument.

3. Specifications and Controls

3.1. Hypot III Functional Specifications

INPUT	
Voltage	115/230 VAC \pm 10%, user selectable
Frequency	50/60 Hz \pm 5%
Fuse	3.15 Amp, fast acting 250VAC
DIELECTRIC WITHSTAND TEST MODE	
Output Rating	5000V @ 20 mA AC 6000V @ 7.5 mA DC
Voltage Setting	Range: 0 - 5.00KV AC 0 - 6.00KV DC Resolution: 0.01KV Accuracy: \pm (2% of setting + 5V) (Can be adjusted during operation. Disabled when key lockout is active.)
Maximum Limit	AC Range: 0.00 - 20.00 mA Resolution: 0.01 mA DC Range: 0 - 7500 μ A Resolution: 1 μ A Accuracy: AC and DC \pm (2% of setting + 2 counts)
Minimum Limit	AC Range: 0.000 - 9.999 mA Resolution: 0.001 mA DC Range: 0.0 - 999.9 μ A Resolution: 0.1 μ A Accuracy: AC and DC \pm (2% of setting + 2 counts)
Arc Detection	Range: 0 - 9, 0 disabled
Failure Detector	Audible and Visual
Ground Fault Interrupt	GFI Trip Current: 450 μ A max (AC or DC) HV Shut Down Speed: <1ms
Voltage Display	Range: 0.00 - 5.00KV AC 0.00 - 6.00KV DC Resolution: 0.01KV Accuracy: \pm (2% of reading + 0.01KV)

DIELECTRIC WITHSTAND TEST MODE	
Current Display	Auto Range AC Range 1: 0.000mA - 3.500mA Resolution: 0.001mA Range 2: 3.00 - 20.00 mA Resolution: 0.01 mA DC Range 1: 0.0 μ A - 350.0 μ A Resolution: 0.1 μ A Range 2: 0.300 mA - 3.500 mA Resolution: 0.001 mA Range 3: 3.00 mA - 7.50 mA Resolution: 0.01mA Accuracy: All Ranges \pm (2% of reading + 2 counts)
DC Output Ripple	\leq 5% Ripple RMS at 6 KV DC @ 7.5 mA, Resistive Load
Discharge Time	\leq 200 ms The maximum capacitive load vs output voltage : 0.20 μ F --- < 1KV 0.050 μ F --- < 4KV 0.10 μ F --- < 2KV 0.040 μ F --- < 5KV 0.06 μ F --- < 3KV 0.015 μ F --- < 6KV
AC Voltage Wave Form	Sine Wave, Crest Factor = 1.3 - 1.5, <2% THD
Output Frequency	Range: 50 or 60 Hz, User Selectable Accuracy: \pm 0.1%
Output Voltage Regulation	\pm (1 % of output + 5 volts) from no load to full load and over input voltage range.
Dwell Timer	Range: AC: 0, 0.3 - 999.9 sec (0 = Constant) DC: 0, 0.4 - 999.9 sec (0 = Constant) Resolution: 0.1 sec Accuracy: \pm (0.1% of reading + 0.05 sec)
Ramp Timer	Range: Ramp-Up: 0.1 - 999.9 sec Ramp-Down: AC 0.0 - 999.9 sec DC 1.0 - 999.9 sec 0=OFF Resolution: 0.1 sec Accuracy: \pm (0.1% of reading + 0.05 sec)
Ground Continuity Current	DC 0.1 A \pm 0.01A, fixed
Ground Continuity Maximum Limit	Range: 0.0 Ω - 1.50 Ω
Ground Continuity Minimum Limit	Resolution: 0.01 Ω
Ground Continuity Auto Offset	Accuracy: \pm (3% of setting + 0.02 Ω)
	Range: 0.0 Ω - 0.50 Ω
	Resolution: 0.01 Ω
	Accuracy: \pm (3% of setting + 0.02 Ω)

INSULATION RESISTANCE TEST MODE																									
Voltage Setting	Range: 30 - 1000V DC Resolution: 1V Accuracy: \pm (2% of setting + 5 volts)																								
Voltage Display	Range: 0 - 1000 V Resolution: 1V Accuracy: \pm (2% of reading + 2 counts)																								
Resistance Display	Range: 1 - 9999 M Ω (4 Digit, Auto Ranging) Resolution: <table style="margin-left: 40px; border-collapse: collapse;"> <tr> <td></td> <td style="text-align: center;">500VDC</td> <td style="text-align: center;">-</td> <td style="text-align: center;">1000VDC</td> </tr> <tr> <td style="text-align: center;">MΩ</td> <td></td> <td></td> <td style="text-align: center;">MΩ</td> </tr> <tr> <td style="text-align: center;">0.001</td> <td style="text-align: center;">1.000</td> <td style="text-align: center;">-</td> <td style="text-align: center;">9.999</td> </tr> <tr> <td style="text-align: center;">0.01</td> <td style="text-align: center;">10.00</td> <td style="text-align: center;">-</td> <td style="text-align: center;">99.99</td> </tr> <tr> <td style="text-align: center;">0.1</td> <td style="text-align: center;">100.0</td> <td style="text-align: center;">-</td> <td style="text-align: center;">999.9</td> </tr> <tr> <td style="text-align: center;">1</td> <td style="text-align: center;">1000</td> <td style="text-align: center;">-</td> <td style="text-align: center;">9999</td> </tr> </table> Accuracy: \pm (2% of reading + 2 counts) at test voltage 500 - 1000V and 1 - 999.9 M Ω \pm (5% of reading + 2 counts) at test voltage 500 - 1000V and 1000 - 9999 M Ω \pm (8% of reading + 2 counts) at test voltage 30 - 500V and 1 - 1000 M Ω		500VDC	-	1000VDC	M Ω			M Ω	0.001	1.000	-	9.999	0.01	10.00	-	99.99	0.1	100.0	-	999.9	1	1000	-	9999
	500VDC	-	1000VDC																						
M Ω			M Ω																						
0.001	1.000	-	9.999																						
0.01	10.00	-	99.99																						
0.1	100.0	-	999.9																						
1	1000	-	9999																						
Maximum Limit	Range: 0,1 - 9999 M Ω (0 = Off) Resolution 1M Ω Accuracy Same as Resistance display																								
Minimum Limit	Range: 1 - 9999 M Ω Resolution 1M Ω Accuracy Same as Resistance display																								
Short Circuit Current	Maximum: 9mA _p																								
Ramp Timer	Range: Ramp-Up: 0.1 - 999.9 sec Ramp-Down: 1.0 - 999.9 sec 0=OFF Resolution: 0.1 sec Accuracy: \pm (0.1% of reading + 0.05 sec)																								
Delay Timer	Range: 0, 0.5 - 999.9 sec (0 = Constant) Resolution: 0.1 sec Accuracy: \pm (0.1% of reading + 0.05 sec)																								
Ground Fault Interrupt	GFI Trip Current: 450 μ A max HV Shut Down Speed: <1ms																								

GENERAL	
Remote Control And Signal Output	The following input and output signals are provided through two 9 pin D type connectors; 1. Remote control : Test, Reset, and Remote Interlock. 2. Remote recall of memory program #1, #2 and #3 3. Outputs : Pass, Fail, Test-in-Process, and Reset
Program Memory	10 Memories, 3 steps per memory, all steps within a memory are linkable.
Security	Key Lock capability to avoid unauthorized access to all test parameters. Memory Lock capability to avoid unauthorized access to memory locations.
Safety	Built-in Smart GFI circuit
Display	128 x 64 dot resolution with front panel contrast setting.
Alarm Volume Setting	Front panel adjustable volume setting with 10 set points.
Line Cord	Detachable 7 ft. (2.13m) power cable terminated in a three prong grounding plug.
Terminations	Detachable 5ft.(1.52m) high voltage and return leads (2) with clips and a standard U.S. style (NEMA 5-15) remote receptacle box for testing items terminated with a line cord. International receptacles also available. Front and Rear outputs standard.
Mechanical	Tilt up front feet. Dimensions: (W x H x D) (215 x 89 x 370 mm) Weight: 20.96 lbs. (9.53Kgs)
Environmental	Operating Temperature : (0° - 40°C) Relative Humidity - 0 to 80%
Calibration	Traceable to National Institute of Standards and Technology (NIST). Calibration controlled by software. Adjustments are made through front panel keypad in a restricted access calibration mode. Calibration information stored in non-volatile memory.

3.2. Instrument Controls

3.2.1. Front Panel Controls

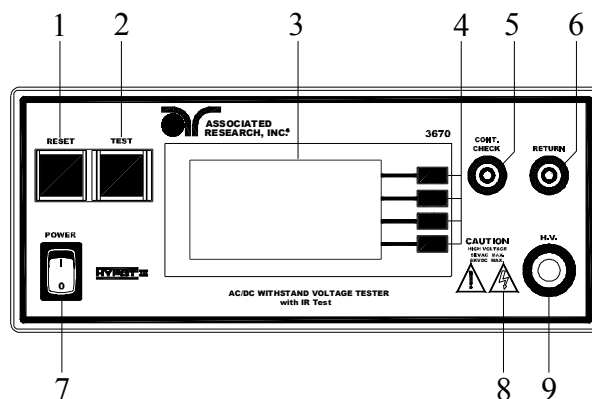

1. **RESET BUTTON:** Momentary contact switch used to reset the instrument. If a failure condition occurs during a test, you will need to reset the system to shut off the alarm and signal the system that you are aware of a failure condition. The reset button must be pressed before you can proceed to the next test or change any of the set-up parameters. This switch also serves as an abort signal to stop any test in progress controlled by the Hypot III.
2. **TEST BUTTON:** Momentary contact switch used to start tests. Press the green button to activate the test that is set up in the test buffer shown on the display.
3. **GRAPHIC LCD:** 128 X 64 Monographic LCD.
4. **SOFT KEYS:** Multifunction parameter selection keys. Keys used to select screens and change parameters.
5. **CONTINUITY OUTPUT JACK:** Connection for the low current return lead used for continuity testing.
6. **RETURN OUTPUT JACK:** Connector used to attach the Return test lead, adapter box return lead, or test fixture return lead to the instrument. This connections provides the return current path for the high voltage and ground bond current.
7. **POWER SWITCH:** Rocker style power switch with international ON (|) and OFF (0) markings.
8. **HIGH VOLTAGE ON INDICATOR:** This indicator flashes to warn the operator that high voltage is present at the high voltage terminal.
9. **HIGH VOLTAGE OUTPUT JACK:** Connector used to attach the High Voltage test lead, adapter box high voltage lead, or test fixture high voltage lead to the instrument. The connector is recessed for safety when not being used.

3.2.2. Rear Panel Controls

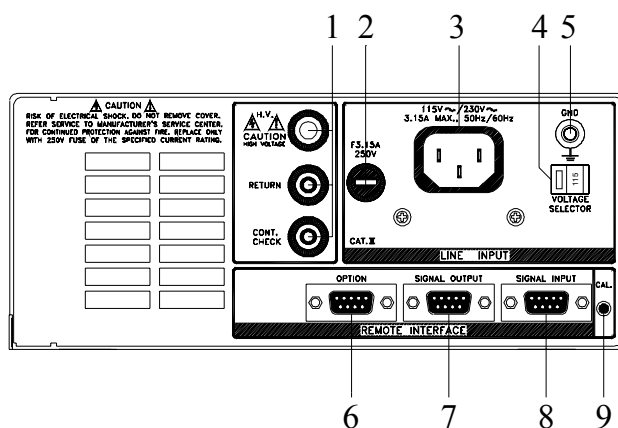

1. **REAR PANEL OUTPUT CONNECTORS:** These connectors are in parallel with the front panel connectors.
2. **FUSE RECEPTACLE:** To change the fuse, unplug the power (mains) cord and turn the fuse receptacle counter-clockwise. The fuse compartment will be exposed. Please replace the fuse with one of the proper rating.
3. **INPUT POWER RECEPTACLE:** Standard IEC 320 connector for connection to a standard NEMA style line power (mains) cord.
4. **INPUT POWER SWITCH:** Line voltage selection is set by the position of the switch. In the left position it is set for 115 volt operation, in the right position it is set for 230 volt operation.
5. **CHASSIS GROUND (EARTH) TERMINAL:** This terminal should be connected to a good earth ground before operation.
6. **OPTION CONNECTOR:** Undefined.
7. **REMOTE SIGNAL OUTPUT:** 9-Pin D sub-miniature female connector for monitoring PASS, FAIL, and PROCESSING output relay signals.
8. **REMOTE SIGNAL INPUT:** 9-Pin D subminiature male connector for remote control of test, reset, and interlock functions, as well as remote program memory selection.
9. **CALIBRATION BUTTON:** To put the instrument into the calibration mode, push this button and turn on the power switch simultaneously.

3.3. Quickstart

This quick start guide assumes the operator has some familiarity with automated Electrical Safety testing.

WARNING

Locate a suitable testing area and be sure you have read all safety instructions for the operation of the instrument and suggestions on the test area set-up in the Safety section. Locate a three prong grounded outlet. Be sure the outlet has been tested for proper wiring before connecting the instrument to it.

CAUTION

Check to be sure that the correct input line voltage has been selected on the rear panel, either 115 volts AC or 230 volts AC. Connect the power-input plug into its socket on the rear panel of the instrument. Connect the male end of the plug to the outlet receptacle. Please be sure that the safety ground on the power line cord is not defeated and that you are connecting to a grounded power source.

Turn on the POWER switch located on the lower left-hand side of the front panel. The initialization screen will appear with a message at the bottom indicating <TEST> to verification. You now have the option to press the TEST button and activate the Verification Menu (Refer to the section **Instrument Verification**). The option to activate the Verification expires approximately 3 seconds after power-up. If you do not press the TEST button within the 3-second window, the initialization screen will disappear. The initialization screen will appear as follows:

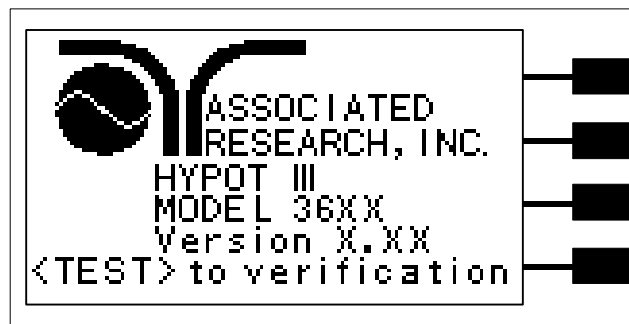

After the initialization screen disappears, the Perform Tests screen will be displayed. The Perform Tests screen will appear as follows:

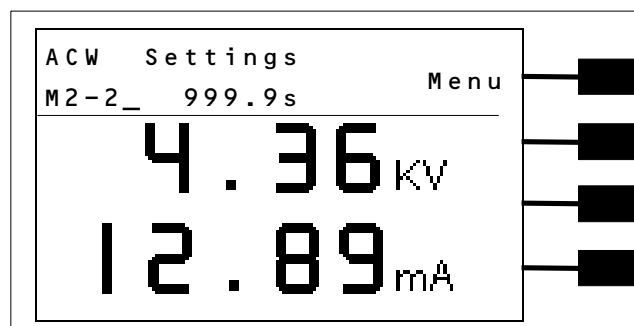

The Hypot III comes with all of the memories and steps loaded with the AC withstand default parameters. The initial test loaded for use is Memory 1, Step 1. If this test is unacceptable for your DUT then refer to the section **4.3 Setting Up a Test**, for instructions on how to program tests into the instrument.

If these parameters are acceptable then connect an appropriate set of test leads to the device under test (DUT) or test fixture. Connect the return lead (Black) to the DUT or test fixture followed by the high voltage output lead (Red). Make sure the safety ground of this instrument is connected to a known good ground.

Refer to section **4.1.3 System Parameters**, Smart GFI, for an explanation of DUT grounding configurations.

WARNING

DO NOT TOUCH THE DEVICE UNDER TEST ONCE THE TEST HAS BEEN STARTED.

Remote Interlock

Hypot III is equipped with a feature referred to as “Remote Interlock”. Remote Interlock is a feature that utilizes a set of closed contacts to enable the instruments output. In other words, if the Interlock contacts open, the output of the instrument will be disabled. Remote Interlock could also be referred to as a remote system lockout, utilizing “Fail When Open” logic. If the Interlock contacts are open and the Test button is pushed, a pop-up message will be displayed on the screen for two seconds. The message will appear as follows:

Interlock is Open

If the Interlock contacts are opened during a test, the pop-up message will be displayed and the test will abort. The hardware has been configured to provide the interlock connections on pins 4 and 5 of the Remote Interface, Signal Input port. The instrument can still be used without the external interlock device as long as the Interlock Connector (38075 provided with unit) is plugged into the Remote Interface, Signal Input port. If there is nothing connected to the Remote Interface, Signal Input port to provide a connection to the interlock, the instrument will not perform tests.

Please check your connections to be sure they are making good contact. Clear the area of any debris that may create a hazardous situation and ask any unnecessary personnel to leave the area. To initiate the test, press the GREEN test button on the front panel. This is a momentary button and does not need to be held in the pressed position during the test. The instrument will then initiate the test presently loaded (in this case Memory 1, Step 1) .

If the DUT passes the test, you will hear a short audible beep. If a failure occurs you will hear a long audible alarm and the red failure indicator will light up. If a failure occurs during the test, a continuous alarm will sound and the red indicator light in the Reset button will illuminate.

To stop the alarm you must press the illuminated RED button marked “RESET.” This will silence the alarm, clear the red fail light, and reset the instrument for the next test. The RESET button may also be used to quickly ABORT a test and cut off the power to the DUT.

When a test is being performed, a red lightning bolt indicator located in the lower right side of the front panel will illuminate and flash until the test is finished. If the DUT passed the test, you will hear a brief beep indicating the DUT passed and that the tests are complete.

Reviewing results

The most direct method for reviewing test results is to press the bottom soft key at the end of the test. Pressing the bottom soft key from the Perform Test screen will display the Results screen. For more information about reviewing test results, refer to section **4.2.3 Reviewing Test Results**.

4. Programming Instructions

4.1. Setup System (Refer to FIG.1).

1. From the Perform Test screen, press the “Menu” soft key. The Main Menu will now be displayed.
2. From the Main Menu screen, press the “Menu” soft key. The Results, Tests and System selections will now be displayed.
3. From this screen, press the System soft key. The Setup System menu will now be displayed.
4. At the Setup System menu, scrolling from the PLC Remote parameter is restricted to down only. Press the down arrow key to access system parameters.
5. Scrolling to <More> will display the second page of System Parameters.

From the Setup System screen, fourteen different Hardware and Software controls may be accessed; PLC Remote, Single Step, Alarm, Contrast, Results, Lock, Mem Lock, Smart GFI, Cal Alert, Cal Date, Cal Due, Alert, Date, and Time. Pressing the EXIT key at any time will return you to the Perform Test screen.

FIG.1

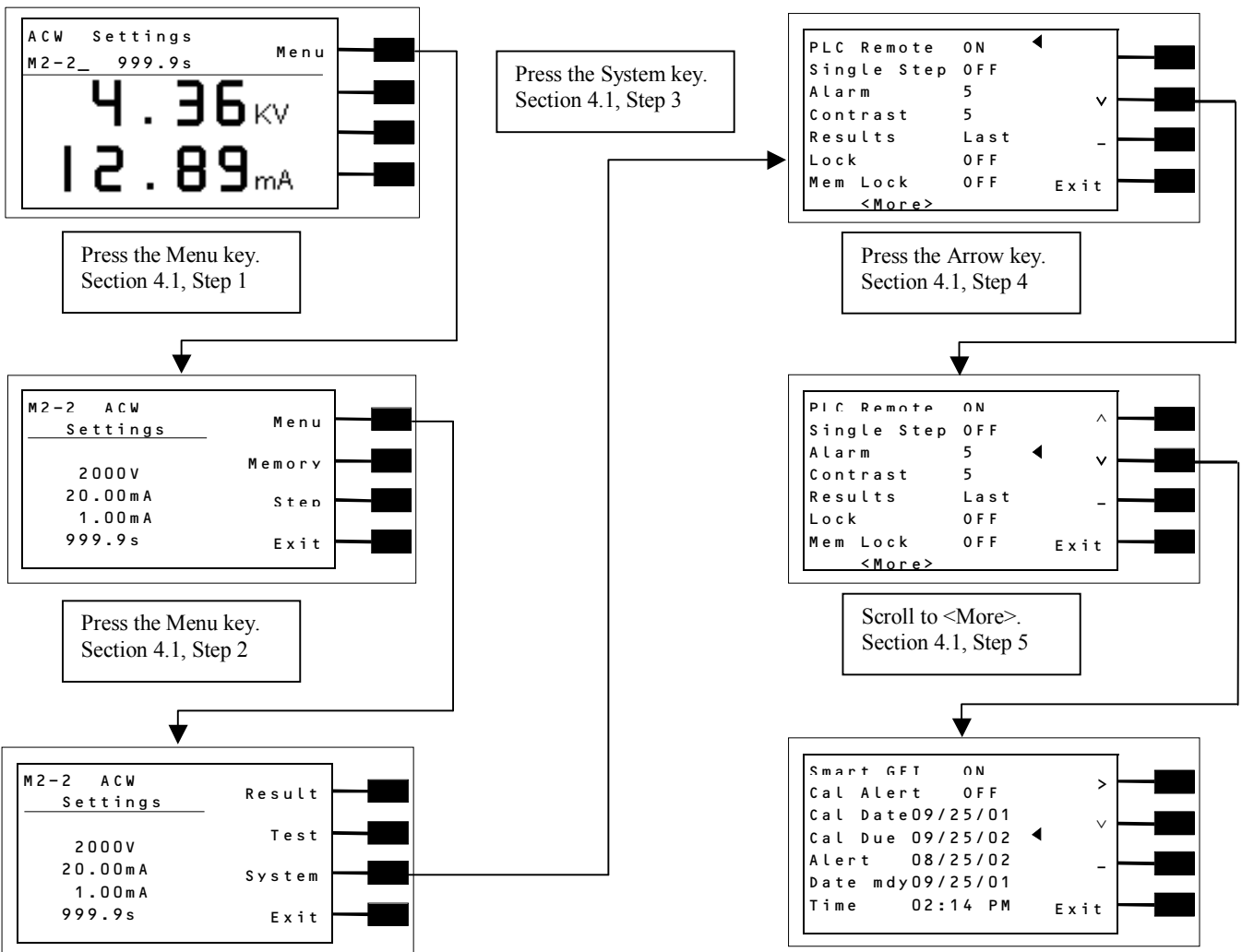

4.1.1. Setup System Soft keys

Directional soft keys >, ^, v

The “>, ^, v” soft keys are used to scroll the cursor to the different system parameters.

+

The “+” and soft key is used to increase or decrease numerical values or toggle settings ON and OFF.

Exit

The Exit soft key is used to return to the Perform Tests screen.

4.1.2. System Parameters

Directional soft keys, v (down), ^(up), and >(right), are used to navigate the System parameters during reviewing and editing. The directional soft keys in the system parameters will change depending on which parameter the cursor is pointing to. At the PLC remote parameter, only the down arrow key is available.

PLC Remote

Scroll the cursor to the PLC Remote parameter using the directional soft keys. When the cursor is pointing to the PLC Remote parameter, you may turn the PLC remote function ON and OFF by pressing the “+” soft key. Refer to the section **6.Connection of Remote I/O** for details.

When the PLC remote is turned “ON”, the front panel Test button is disabled and a test may only be started through the rear panel I/O. If you attempt to start a test from the front panel Test button when the PLC Remote function is turned “ON”, a pop-up message will be displayed. The pop-up message will appear as follows:



PLC Remote ON

Single Step

Scroll the cursor to the Single Step parameter using the directional soft keys. When the cursor is pointing to the Single Step parameter, you may turn the function ON and OFF by pressing the “+” soft key.

This function is used to temporarily override the automatic connection feature. When the Single Step function is ON the instrument will pause after each step is completed. To continue the test sequence, press the Test button to execute the next connected step. Each time the Test button is pressed the next connected step will execute. If you press the Reset button before completing all connected steps, it will return you to the original starting step. If a step fails and you wish to continue to the next step do not press Reset.

Alarm Volume

Scroll the cursor to the Alarm parameter using the directional soft keys. When the cursor is pointing to the Alarm parameter, you may use the “+” soft key to increase and decrease the volume of the Alarm.

The numbers corresponding to the different volume settings are 0 through 9, 0 meaning the volume is off and 9 being the loudest setting. After the “+” or is pressed, a momentary alarm chirp will occur to indicate the volume of the new setting.

LCD Contrast

Scroll the cursor to the Contrast parameter using the directional soft keys. When the cursor is pointing to the Contrast parameter, you may use the “+” soft key to increase and decrease the contrast of the LCD display.

The numbers corresponding to the different contrast settings are 0 through 9, 0 meaning the lightest color of displayed characters and 9 meaning the darkest color of displayed characters. After the “+” is pressed, the display will automatically adjust to the new display setting.

Results

Scroll the cursor to the Results parameter using the directional soft keys. When the cursor is pointing to the Results parameter, you may use the “+” soft key to select what type of results you would preferred displayed at the end of a test or sequence of connected steps. The available selections are: All, P/F and Last.

When All is selected, a Results summary screen will be displayed at the end of the test or sequence of connected steps, displaying the results of all of the steps. The Results summary screen will appear as follows:

A C W	P a s s	9 9 9 . 9 s	■
M 2 - 1	5 . 0 0 K V	2 0 . 0 0 m A	
-----			■
D C W	P a s s	9 9 9 . 9 s	
M 2 - 2	1 . 2 0 K V	2 0 0 0 u A	■

T R	P a s s	9 9 9 . 9 s	
M 2 - 3	1 . 0 0 K V	1 0 . 0 0 M Ω	■

When P/F is selected, a Pass or Fail screen will be displayed at the end of the test. The Pass and Fail screens will appear as follows:

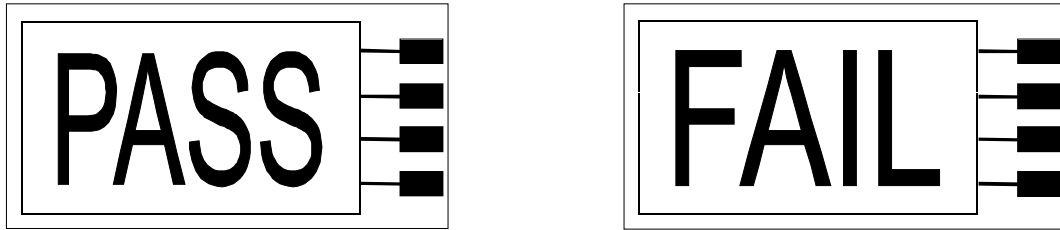

When P/F is selected, it is not possible to directly see the test results at the end of the test. In order to review the test results refer to section **4.2.3 Reviewing Test Results**.

When Last is selected, the results of the last step performed will be displayed on the Perform Tests screen. There will not be a change in appearance or special screen displayed in this mode.

Lock

Scroll the cursor to the Lock parameter using the directional soft keys. When the cursor is pointing to the Lock parameter, you may turn the function ON and OFF by pressing the “+” soft key. When the exit soft key is pressed, the security settings will take immediate effect.

Selecting Lock “ON” restricts access to parameter and system settings. The level of security is determined by the Mem Lock function.

Once the Lock function is activated, a special procedure is required to defeat the security. To defeat the security, press the top soft key while powering up the instrument. Now you may access the system menu and turn the security function OFF.

Mem Lock

Scroll the cursor to the Mem Lock parameter using the directional soft keys. When the cursor is pointing to the Mem Lock parameter, you may turn the function ON and OFF by pressing the “+” soft key.

Mem Lock is a sub-function of the Lock setting. In order for the Mem Lock function to work, the Lock must first be turned “ON”. Selecting the Mem Lock “OFF” will allow the user to access all available Memory locations and steps but restricts access to memory and step editing capabilities. Selecting the Mem Lock “ON” will allow the user to only run the currently loaded memory.

Smart GFI

Scroll the cursor to the Smart GFI parameter using the directional soft keys. When the cursor is pointing to the Smart GFI parameter, you may turn the function ON and OFF by pressing the “+” soft key.

The High Voltage power supply of the instrument is internally referenced to earth ground. The leakage current measuring circuits monitor only currents that flow through the Return lead. Therefore, the possibility exists for current to flow directly from the High Voltage output to earth ground that typically would not be monitored.

GFI is a circuit that monitors the current between the High Voltage output and earth ground. The GFI's main purpose is to protect the operator from prolonged exposure to High Voltage in the case of an accidental contact with the High Voltage lead and earth ground. If the operator accidentally touches the High Voltage lead and earth ground, the High Voltage will be shut off immediately and the test aborted. If the GFI threshold is exceeded, the display will indicate a GFI Fail.

Smart GFI allows the user to automatically configure the instruments return configuration. When the Return lead is earth grounded, the GFI circuit is disabled and the instrument operates in a grounded return mode of operation. Grounded Return allows the user to perform tests on devices that have their chassis earth grounded by the test fixture or test environment. The standard configuration of Hypot III is a floating return connection that is not directly connected to Earth ground. The standard configuration allows monitoring of very low level leakage current without internal or external stray earth ground leakage currents being measured and thereby causing errors in the reading. Grounding the return will create some amount of leakage current that is proportional to the High Voltage output and can cause small amounts of error depending on the test voltage and physical environment.

Cal Alert (Calibration Alert)

Calibration Alert is a feature that allows the instrument to give an advanced alert that the calibration for the instrument is coming due. Scroll the cursor to the Cal Alert parameter using the directional soft keys. When the cursor is pointing to the Cal Alert parameter, you may turn the function ON and OFF by pressing the “+” soft key.

Turning this parameter “ON” will activate the Cal Alert function and when the date matches the Alert Date, the instrument will display the Calibration Alert warning screen upon power up. If the “Show this screen again?” function has been turned “OFF” at the Calibration Alert Warning screen, this parameter will automatically be set to “OFF”.

Cal Date(Calibration Date)

Calibration Date is a non-editable parameter that indicates the Date when calibration was last performed on the instrument. This parameter automatically updates after calibrating the instrument.

Cal Due (Calibration Due Date)

It is recommended that calibration should be performed at least once a year. It is recommended that the Calibration Due date not be set greater than one year from the Calibration Date displayed. After a calibration is performed, the Calibration Due Date is automatically set 1 year after the calibration date.

This parameter defaults to one year after the calibration date but may be overwritten to any advanced date desired. Within the Calibration Due Date parameter are three separate fields, month, day, and year. Use the > key to select the field within the date you want to edit then use the + key to change the numeric value. Once you change the value, it is automatically stored.

Alert (Alert Date)

The Alert date is like an alarm clock that will warn you in advance of the actual calibration due date. After a calibration is performed, the Alert Date is automatically set 11 months after the calibration date. For example, if the calibration is performed on 12/15/2002 the Alert Date will automatically be set to 11/15/2003.

This parameter defaults to 11 months after the calibration date but may be overwritten to any advanced date desired. Within the Alert Date parameter are three separate fields, month, day, and year. Use the > to select the field within the date you want to edit. Use the + key to change the numeric value. Once you change the value, it is automatically stored.

Date

Scroll the cursor to the Date parameter using the directional soft keys.

Within the Set Date parameter are four fields, date format (mdy / dmy), month, day, and year. Use the > key to select the field within the date you want to edit. Using the + key to change the numeric value. Once you change the value, it is automatically stored.

Time

Scroll the cursor to the Time parameter using the directional soft keys.

Within the Set Time parameter are three fields, hours, minutes, and Military or Standard time setting. Use the > key to select the field within the time parameter you want to edit. Use the + key to change the numeric value. Once you change the value, it is automatically stored.

The Calibration Alert Warning screen appears as follows:

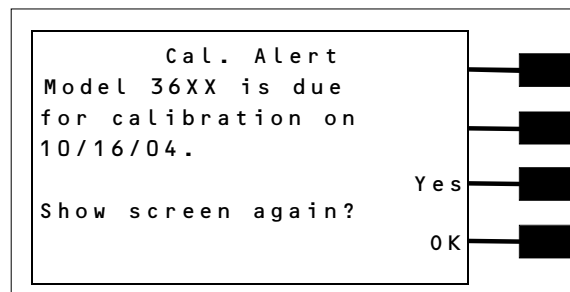

At the Calibration Alert Warning screen, there are two options, “Show screen again? Yes or No”. “Show screen again?” is asking if you would like to continue seeing the Calibration Alert

Warning screen every time you power up the instrument. The question must be answered by toggling between the word “Yes” and “No” using its corresponding softkey and then pressing the OK softkey. You may turn this screen “OFF” by toggling to the word “No” using the soft key next to this parameter and pressing the OK soft key. Selecting the “Show this screen again” parameter “No” will disable the Calibration Alert function. You may leave this screen “ON” by toggling to the word “Yes” using the soft key next to this parameter and the pressing the OK soft key. Selecting the “Show this screen again” parameter “Yes” will exit the Calibration Alert Warning screen and go to the standard introduction screen without disabling the Calibration Alert function.

If security is enabled you will not see the question “Show screen again” or the Yes/No soft key.

It is possible to quickly bypass the security of the Calibration Alert by powering up the instrument while depressing the soft key that is second from the top of the instrument. This will temporarily start the instrument in an unsecured state. The Calibration Alert Warning screen will be displayed and allow you to disable the Calibration alert by selecting “No” and then pressing the OK soft key. This type of security override only affects the Calibration alert screen. It is not necessary to restart the instrument to activate the security setting.

4.2. Setting up Tests (Refer to FIG.2).

4.2.1. Reviewing Test parameters

1. From the Perform Test screen, press the “Menu” soft key. The Main Menu will now be displayed.
2. Select the memory and step location you want to review or edit using their corresponding soft keys.
3. From the Main Menu screen, press the “Menu” soft key. The Results, Tests and System selections will now be displayed.
4. From this screen, press the Test soft key. The Test parameter review screen will now be displayed (For the example an AC withstand test is displayed). You may now review the test parameters by scrolling the cursor with the up and down arrow keys. It is important to note that there are two screens of parameters for AC and DC withstand tests.

FIG.2

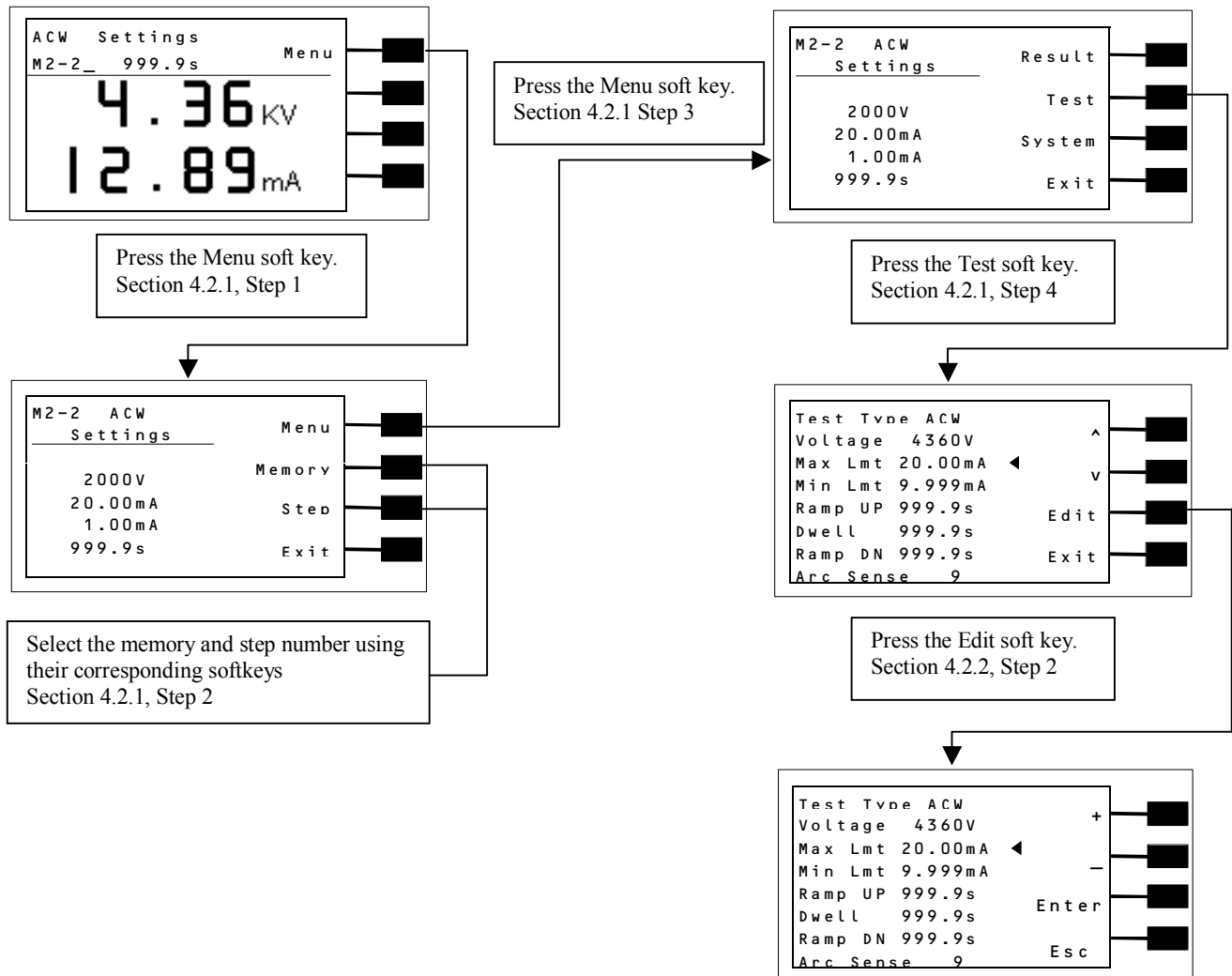

4.2.2. Editing Test Parameters (Refer to FIG.2)

1. From the Test parameter review screen (refer to section 4.2.1), scroll the cursor to the test parameter you wish to edit using the up and down arrow soft keys.
2. Press the Edit soft key. The Test parameter edit screen will now be displayed.
3. You may now change the value of the test parameter with the up and down arrow soft keys.
4. Press the Enter soft key to accept the new value or press Esc to escape from the edit.

All available test parameters may be edited using this procedure.

4.2.3. Reviewing Test Results

Method 1, Hot key

1. Pressing the bottom soft key at the Perform Test screen will display the Results screen.

Method 2, Menu Selection

1. From the Perform Test screen, press the “Menu” soft key. The Main Menu will now be displayed.
2. From the Main Menu screen, press the “Menu” soft key. The Results, Test and System selections will now be displayed.
3. From this screen, press the “Result” soft key. The Results screen will now be displayed. The Results screen will appear as follows:

M1-1 GND		^	[Soft Key]
Max-Fail			
-----		V	[Soft Key]
Settings	Results		
25.00A	. A		
100mΩ	>120mΩ		
0mΩ	0.0s		
1.0s		Exit	[Soft Key]

For connected tests, use the up and down soft keys to scroll through the results.

4.3. Test Parameters

Description of Test Parameters

Voltage: The Voltage that is applied to the High Voltage and Return terminals or the Current and Return terminals during a test.

Max Lmt: A maximum current or resistance threshold that when exceeded triggers a failure.

Min Lmt: A minimum current or resistance threshold that when not exceeded triggers a failure.

Ramp Up: A length of time that is allowed for the test voltage to climb from 0 to the voltage set point.

Dwell: A length of time that is allowed for the set point voltage to be applied.

Delay: A length of time that the set point voltage is applied but no judgment of the set parameters is made. A judgment of the parameters is not made until the end of the delay time.

Ramp DN: A length of time that is allowed for the test voltage to decay from set point to 0.

Arc Sense: During hipot testing some low current arcing may be allowable. Arc sense is a maximum allowable threshold for arcing.

The numbers corresponding to the different arc sensitivity levels are 0 through 9, 1 meaning the maximum threshold of allowable arcing, 9 meaning the minimum threshold of allowable arcing and 0=OFF. After the “+” or “-” is pressed, the arc sensitivity will automatically adjust to the new setting.

Frequency: This parameter is available in AC tests only and is selectable using a softkey between 50 and 60Hz.

Continuity: This function checks for a connection between the cont. check and return lead. This is a basic DC continuity check that measures the continuity value but does not display it. Continuity may be selected “ON or “OFF” using a softkey.

Connect: This function when turned ON will connect or link the current step to the next step. The third step in a Memory will not have this function because it is the last step of the Memory location.

4.3.2. AC Withstand

From the Test parameter review screen (refer to section 4.2.1), scroll the cursor, using the up and down arrow soft keys, to the Test Type parameter. Press the Edit softkey. Select the AC Withstand parameter using the “+” and “-” soft keys and press the Enter soft key. The default AC Withstand parameters will now be loaded into the currently selected memory and step. Press the Enter softkey to accept the parameters (or press Esc to escape). The AC Withstand parameter review screens will now be displayed. The AC Withstand parameter review screens will appear as follows:

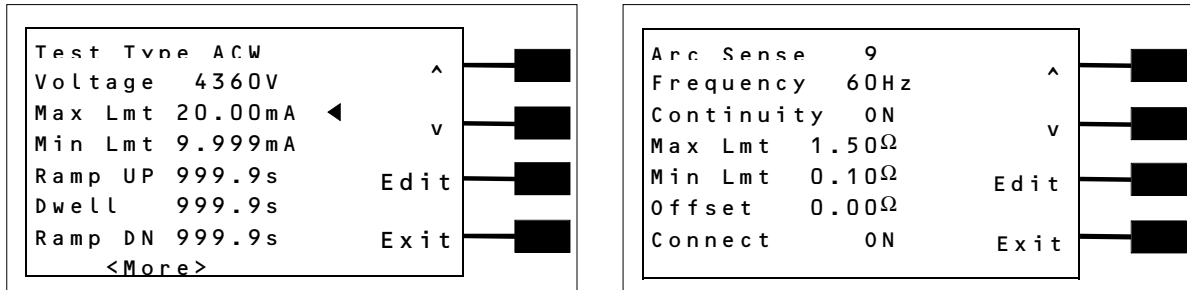

From the AC Withstand review screens the following parameters may be selected for editing: Voltage, Max-Limit, Min-Limit, Ramp Up, Dwell Time, Ramp Down, Arc Sense, LO-Limit, Frequency, Arc Detect (ON/OFF), Continuity selection (On/OFF), Continuity Max Limit, Continuity Min Limit, and Continuity Offset.

Offset

When the Continuity is selected ON, the Offset function may be used to compensate for lead and test fixture resistance during the continuity test. Using the up and down arrow keys, scroll the cursor to the Offset parameter and press the Edit softkey. You may now manually or automatically set an Offset value.

To manually set the Offset, use the “+” and “-” soft keys to increase and decrease the resistance value. Press the Enter soft key to accept the new value or press the Esc soft key to escape from the edit.

To automatically set an Offset value, set the output voltage, current, and frequency to the values that will be used on the DUT and connect the test cables or test fixture with fixturing to the instrument. Next, short circuit the ends of the test cables and press the “TEST” button. The instrument will now read the lead resistance and update Offset parameter automatically. Press the Enter soft key to accept the new value or press the Esc soft key to escape from the edit.

4.3.3. DC Withstand (Models 3665 and 3670)

From the Test parameter review screen (refer to section 4.2.1), scroll the cursor, using the up and down arrow soft keys, to the Test Type parameter. Press the Edit softkey. Select the DC Withstand parameter using the “+” and “-” soft keys and press the Enter soft key. The default DC Withstand parameters will now be loaded into the currently selected memory and step. Press the Enter softkey to accept the parameters (or press Esc to escape). The DC Withstand parameter review screens will now be displayed. The DC Withstand parameter review screens will appear as follows:

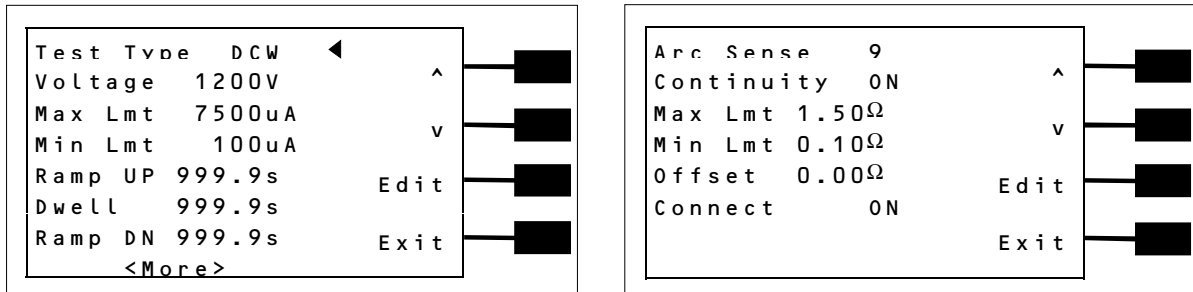

From the DC Withstand setting screen the following parameters may be controlled: Voltage, Max-Limit, Min- Limit, Ramp Up, Dwell Time, Ramp Down, Arc Sense, Ramp-HI, Arc Detect (ON/OFF), and Continuity (ON/OFF).

Offset

When the Continuity is selected ON, the Offset function may be used to compensate for lead and test fixture resistance during the continuity test. Using the up and down arrow keys, scroll the cursor to the Offset parameter and press the Edit softkey. You may now manually or automatically set an Offset value.

To manually set the Offset, use the “+” and “-” soft keys to increase and decrease the resistance value. Press the Enter soft key to accept the new value or press the Esc soft key to escape from the edit.

To automatically set an Offset value, set the output voltage, current, and frequency to the values that will be used on the DUT and connect the test cables or test fixture with fixturing to the instrument. Next, short circuit the ends of the test cables and press the “TEST” button. The instrument will now read the lead resistance and update Offset parameter automatically. Press the Enter soft key to accept the new value or press the Esc soft key to escape from the edit.

4.3.4. Insulation Resistance (Model 3670 only)

From the Test parameter review screen (refer to section 4.2.1), scroll the cursor, using the up and down arrow soft keys, to the Test Type parameter. Press the Edit softkey. Select the IR parameter using the “+” and “-” soft keys and press the Enter soft key. The default IR parameters will now be loaded into the currently selected memory and step. Press the Enter softkey to accept the parameters (or press Esc to escape). The IR parameter review screen will now be displayed. The DC Withstand parameter review screen will appear as follows:

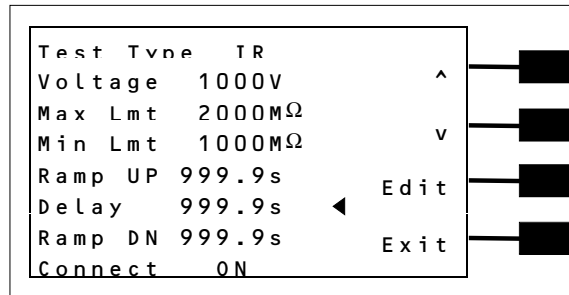

From the Insulation Resistance parameter setting screen the following parameters may be selected for editing: Voltage, Max-Limit, Min- Limit, Ramp Up, Delay Time, and Ramp Down.

4.3.5. Default Parameters

Each of the test types (AC withstand, DC withstand and IR) have specific default test parameters that automatically load when test type is selected from the parameter edit screen. The following table is a listing of the Default Parameters for each of the different types of tests that are available in the Hypot III. The Default Parameters are as follows:

Test Type	Parameter	Value
ACW	Voltage	1,24kV
	Max Lmt (current)	10.00mA
	Min Lmt (current)	0.000mA
	Ramp UP	0.1s
	Dwell	1.0s
	Ramp DN	0.0s
	Arc Sense	0
	Frequency	60Hz
	Continuity	OFF
	Max Lmt (Continuity)	1.00Ω
	Min Lmt (Continuity)	0.00Ω
	Offset (Continuity)	0.00Ω
	Connect	OFF
DCW	Voltage	1,50kV
	Max Lmt (Current)	5000μA
	Min Lmt (Current)	0.0μA
	Ramp UP	0.1s
	Dwell	1.0s
	Ramp DN	1.0s
	Arc Sense	0
	Continuity	OFF
	Max Lmt (Continuity)	1.00Ω
	Min Lmt (Continuity)	0.00Ω
	Offset (Continuity)	0.00Ω
	Connect	OFF
	IR	Voltage
Max Lmt		0MΩ
Min Lmt		10MΩ
Ramp UP		0.1s
Delay		1.0s
Ramp DN		1.0s
Connect		OFF
Setup Sys.		PLC Remote
	Single Step	OFF
	Alarm	5
	Contrast	5
	Results	Last
	Lock	OFF
	Mem Lock	ON
	Smart GFI	ON

5. Operating Instructions

5.1. Instrument Connections

5.1.1. Adapter Box Connections

The adapter box provides an easy way to connect a DUT to the HYPOT III that is terminated in a two or three-prong line cord. The following diagram shows how to connect the adapter box to the Hypot III and to the device under test.

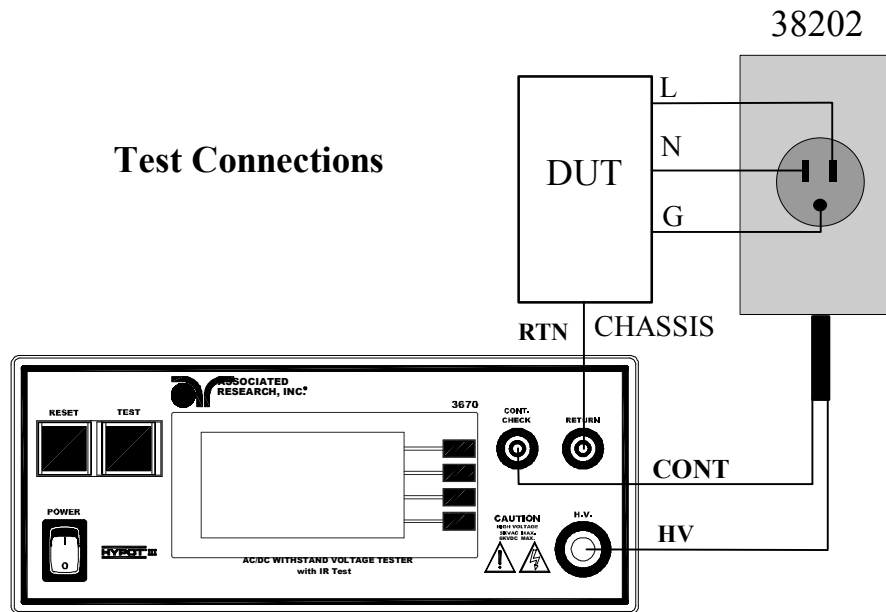

- The rear output connections on the Hypot III may be used as well.

5.2. Perform Tests, Main Menu, and Results Screens

The Hypot III automatically defaults to the Perform Tests screen upon power up. The Perform Tests screen will appear as follows:

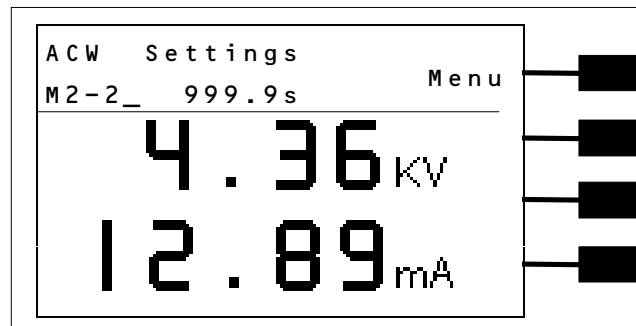

From the Perform Tests screen the Main Menu may be accessed by pressing the Menu softkey

The Perform Tests screen is the main operational screen of instrument. From this screen, test parameters are monitored while the test is being performed. This screen may also be used to debug memories with connected steps, with the use of the single step function.

5.2.1. Connected Step indicator

The connected step indicator is an under score symbol located directly next to the Memory and Step number and only will be displayed when the connect function has been turned “On” in the Test parameters.

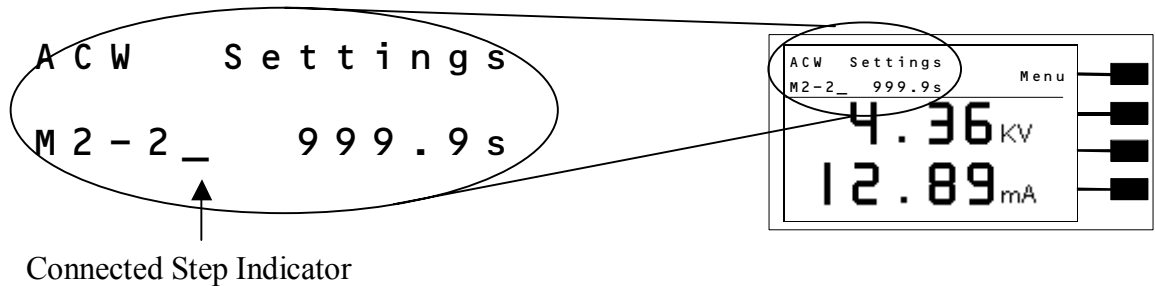

5.2.2. Main Menu

From the Perform Tests screen, press the “Menu” soft key.

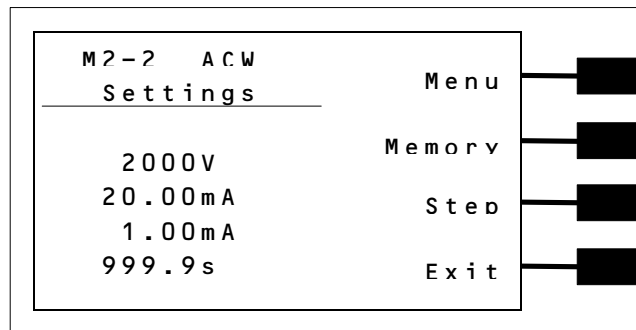

The Main Menu will now be displayed. From the Main Menu screen, three Software controls may be accessed; Menu, Memory, Step. Pressing the Exit soft key at any time will return you to the Perform Tests.

Menu

Pressing the Menu soft key from the Main Menu will display the Results, Tests and System selections. Please refer to section **5.2.3 Results, Test, and System Selections**.

Memory

The Hypot III has 10, three-step programmable memory locations (M0-M9). Press the “Memory” soft key to increment the instrument to the desired memory location. As the Memory softkey is pressed, the parameters of the selected memory location are automatically loaded into the instrument.

Step

Each of the ten memory locations in Hypot III has three programmable steps that may be “Connected” together to create multi-step testing. Press the “Step” soft key to increment the step number.

5.2.3. Results, Tests and System Selections

From the Main Menu, press the “Menu” soft key.

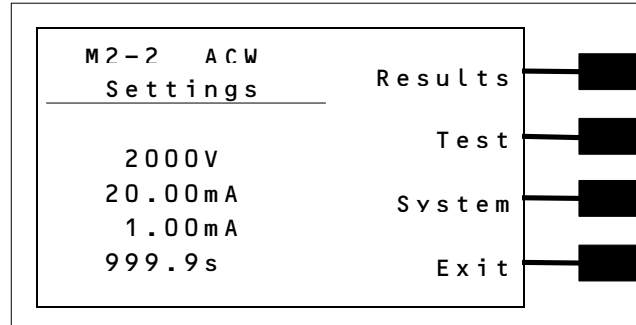

The Results, Tests and System selections will now be displayed. From this screen, three Software controls may be accessed; Results, Test, and System. Pressing the Exit soft key at any time will return you to the Perform Tests screen.

Results

Pressing the “Results” soft key from this menu will allow you to review the test results of the last test performed. An example of a Results screen is shown below.

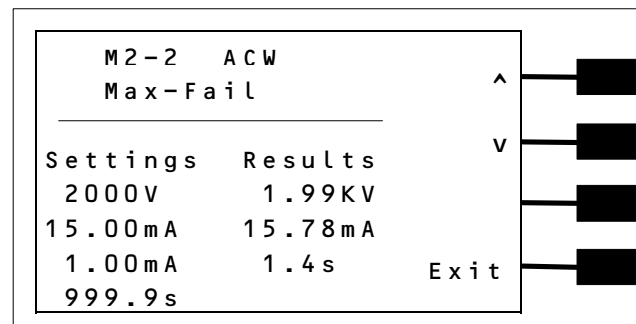

Test

Pressing the “Test” soft key from this menu will allow you to access the Parameter Review screen. For specific instructions for reviewing and editing test parameters, refer to section **4.2 Test Parameters**.

System

Pressing the “System” soft key from this menu will allow you to access the Setup System screen. For specific instructions for editing system parameters, refer to section **4.1 Setup System**.

5.3. Perform Tests Metering

Each test performed by the Hypot III contains a unique set of parameters and therefore requires specialized metering for each test. The following table describes what meters will be displayed for each of the different test types.

Test Type	Current	Voltage	Time	Resistance
AC Withstand	X	X	X	-
DC Withstand	X	X	X	-
IR	-	X	X	X

5.4. Performing a Test

1. From the Main Menu, select the memory and step you wish to perform then press the Exit soft key to return you to the Perform Test screen.
2. Attach the appropriate load or DUT to the instrument (refer to section 5.1 for instrument connections).
3. Press the TEST button.
4. The instrument will now perform the test or connected sequence of tests. If the Test is started from any other step than 01, when you push Reset or Test buttons, it will always return to the originally selected step.

5.4.1. Single Step

Single step is a function that allows you to run one step at a time from a sequence of connected steps. To access the Single step function, refer to section 4.1 **Setup System**. This function is used to temporarily override the automatic connection feature. When the Single Step function is ON the instrument will pause after each step is completed. To continue the test sequence, press the Test button to execute the next connected step. Each time the Test button is pressed the next connected step will execute. If you press the Reset button before completing all connected steps, it will return you to the original starting step. If a step fails and you wish to continue to the next step do not press Reset.

5.4.2. Description of displayed messages.

While performing tests, a number of messages will be displayed to indicate the test state or test results. These messages are displayed in the status area of the screen, located on the first line at the top of the LCD. These messages also used on other screens where test results are displayed.

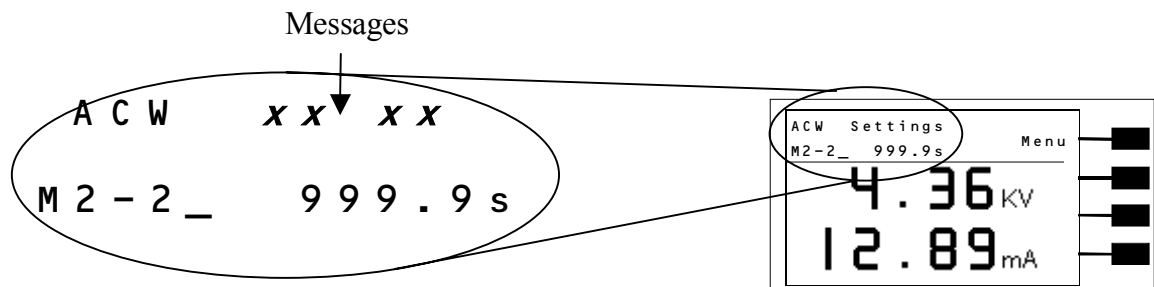

Dwell: This message appears on the display during the AC/DC Withstand test in process, when the values are being updated in real time.

Delay: This message appears on the display during the Insulation Resistance test in process, when the values are being updated in real time.

Ramp UP: This message appears on the display at the beginning of the test, when the output voltage is ramping up.

Ramp DN: This message appears on the display at the end of the dwell or delay cycles, when the output voltage is ramping down.

Pass: This message appears on the display, when the test process is complete and the DUT passed the test.

Abort: This message appears on the display, if the test in process is aborted with the RESET button or remote Reset control.

Max-Fail: This message appears on the display, if the measured reading exceeds the Max Lmt current setting of the AC/DC Withstand test, or Max Lmt resistance setting of the Insulation Resistance test.

Min-Fail: This message appears on the display, if the measured reading drops below the Min Lmt current setting of the AC/DC Withstand test, or Min Lmt resistance setting of the Insulation Resistance test.

Cont. Max: This message appears on the display, if the measured reading exceeds the Max Lmt continuity resistance setting and the Continuity function is set to ON of the AC/DC Withstand test.

Cont. Min: This message appears on the display, if the measured reading drops below the Min Lmt continuity resistance setting and the Continuity function is set to ON of the AC/DC Withstand test.

Arc-Fail: This message appears on the display, if the DUT arcing current exceeds the Arc Sense limit and Arc function is active (Arc Sense = 1...9) of the AC/DC Withstand test.

Short: This message appears on the display, if the DUT current is well beyond the metering range of the test.

Breakdown: This message appears on the display, if the DUT current is well beyond the metering range of the test and the arcing condition is beyond the arc sense limit.

GND-Fault: This message appears on the display, if the GFI threshold is exceeded during the test.

Out-Error: This message appears on the display, after exiting from the Output Error screen. If the instrument has an internal problem and the TEST button is pressed, the Output Error screen will appear as follows:

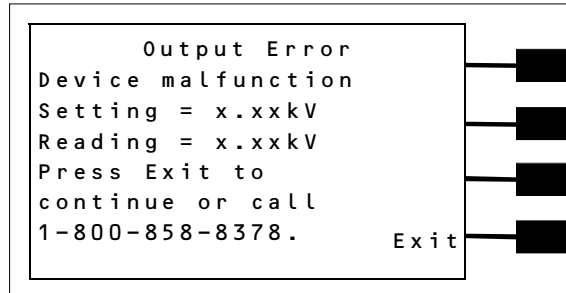

The RESET button is not active while this screen is displayed. To clear this screen and return to test mode the Exit soft key must be pressed. When the Exit soft key is pressed the instrument will continue with its normal failure indication process. The failure light and Alarm can then be cleared by pressing the RESET button.

6. Instrument Verification

Verification is a process by which an instrument's fail detectors are proven to be functioning properly and thereby "Verifying" the functionality of the electrical safety tester and connected accessories. Verification of failure detect circuitry of the electrical safety tester is required by safety agencies such as CSA, UL, and TÜV.

6.1. Verification Initialization

Turn on the POWER switch located on the lower left-hand side of the front panel. The initialization screen will appear with a message at the bottom indicating <TEST> to verification. You now have the option to press the TEST button and activate the Verification Menu. The option to activate the Verification expires approximately 3 seconds after power-up. The Initialization screen will appear as follows:

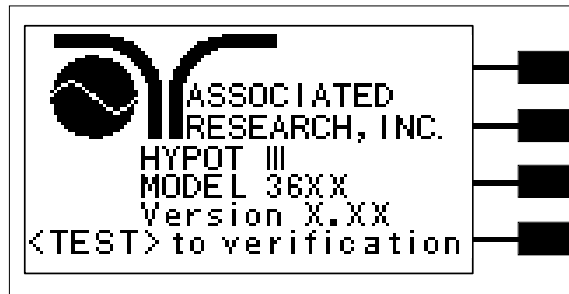

6.2. Verification Menu

From the Initialization screen (First start up screen), press the TEST button. The Verification Menu will now be displayed. From the Verification screen, four different Verification processes may be accessed; Continuity, AC Hipot, DC Hipot, and IR.

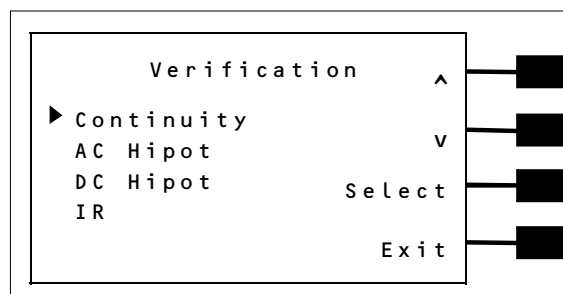

During the Verification process, all Remote control output signals, except the Fail output, are disabled.

6.2.1. Continuity Verification

From the Verification screen, press the Up or Down soft keys to select “Continuity”, then press Select soft key. An instructional prompt will now be displayed. The prompt will appear as follows:

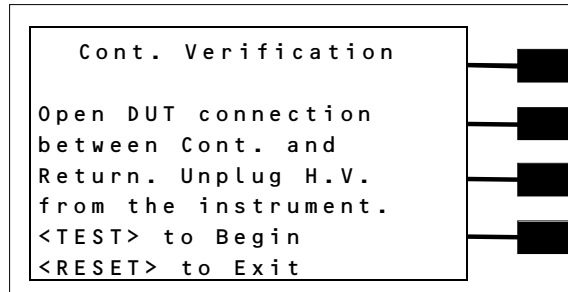

Follow the instructions given in the prompt and then press TEST to begin the verification process.

At the end of the Verification process, a message will appear indicating the outcome of the process. If the instrument passes the Verification (test failure, indicating the fail detectors are working properly) the RESET button will illuminate, the alarm will sound and the following message will appear:

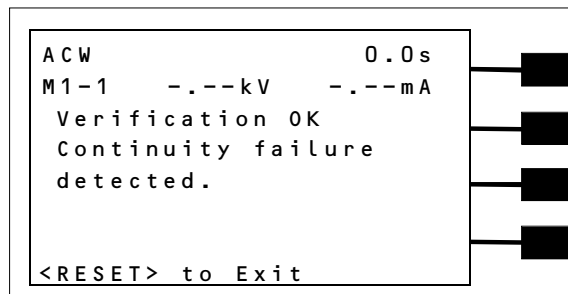

If the instrument fails the Verification (test pass, indicating the fail detectors are not working properly) the following message will appear:

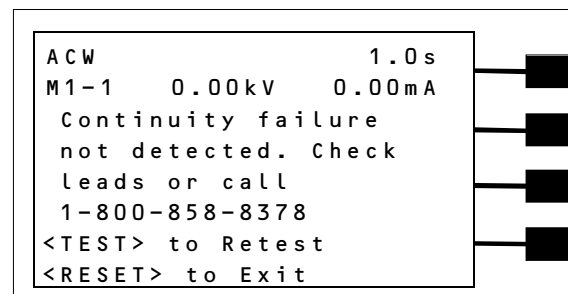

6.2.2. AC Hipot Verification

From the Verification screen, press the Up or Down soft keys to select “AC Hipot”, then press the Select soft key. An instructional prompt will now be displayed. The prompt will appear as follows:

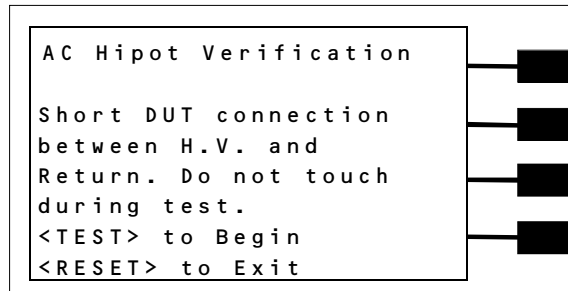

Follow the instructions given in the prompt and then press TEST to begin the verification process.

At the end of the Verification process, a message will appear indicating the outcome of the process. If the instrument passes the Verification (test failure, indicating the fail detectors are working properly) the RESET button will illuminate, the alarm will sound and the following message will appear:

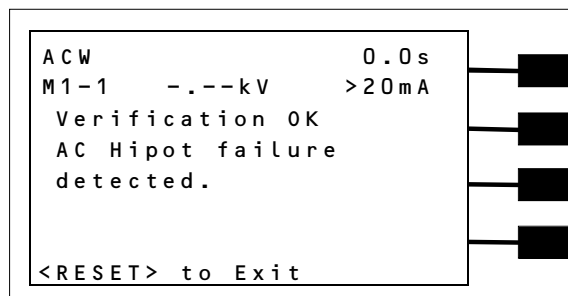

If the instrument fails the Verification (test pass, indicating the fail detectors are not working properly) the following message will appear:

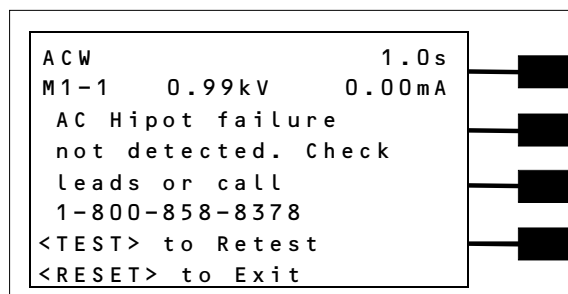

6.2.3. DC Hipot Verification

From the Verification screen, press the Up or Down soft keys to select “DC Hipot”, then press the Select soft key. An instructional prompt will now be displayed. The prompt will appear as follows:

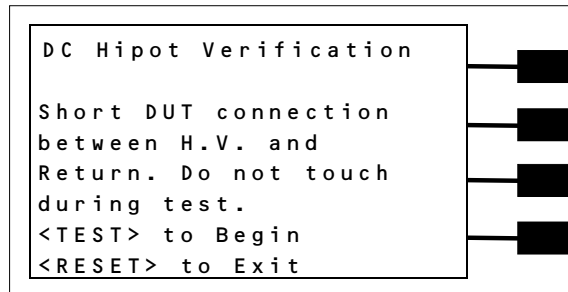

Follow the instructions given in the prompt and then press TEST to begin the verification process.

At the end of the Verification process, a message will appear indicating the outcome of the process. If the instrument passes the Verification (test failure, indicating the fail detectors are working properly) the RESET button will illuminate, the alarm will sound and the following message will appear:

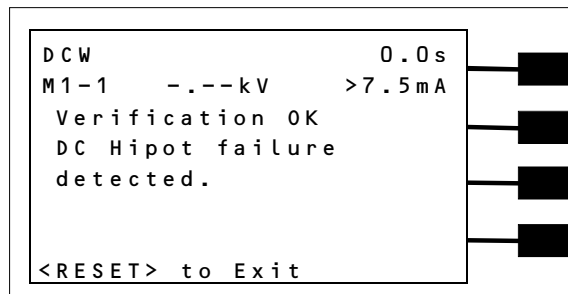

If the instrument fails the Verification (test pass, indicating the fail detectors are not working properly) the following message will appear:

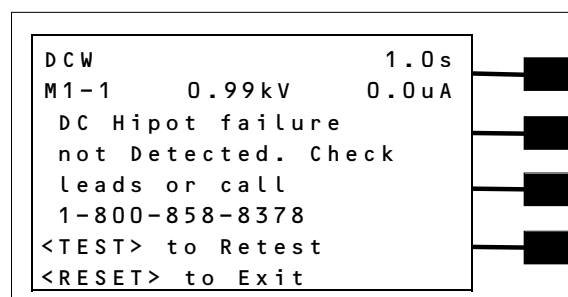

6.2.4. IR Verification

From the Verification screen, press the Up or Down soft keys to select “IR”, then press the Select soft key. An instructional prompt will now be displayed. The prompt will appear as follows:

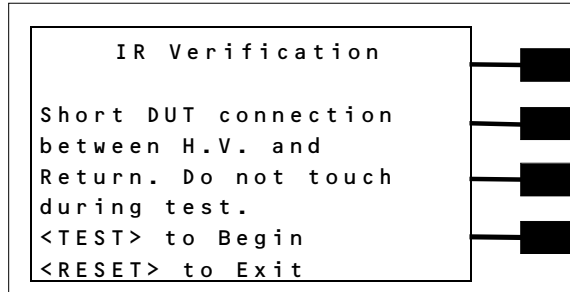

Follow the instructions given in the prompt and then press TEST to begin the verification process.

At the end of the Verification process, a message will appear indicating the outcome of the process. If the instrument passes the Verification (test failure, indicating the fail detectors are working properly) the RESET button will illuminate, the alarm will sound and the following message will appear:

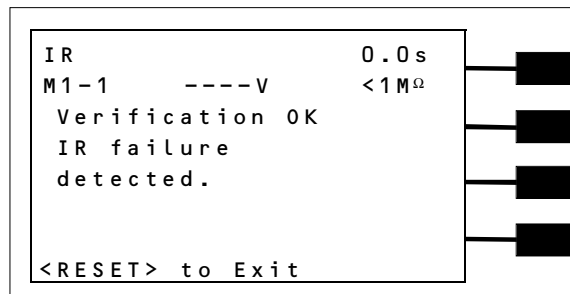

If the instrument fails the Verification (test pass, indicating the fail detectors are not working properly) the following message will appear:

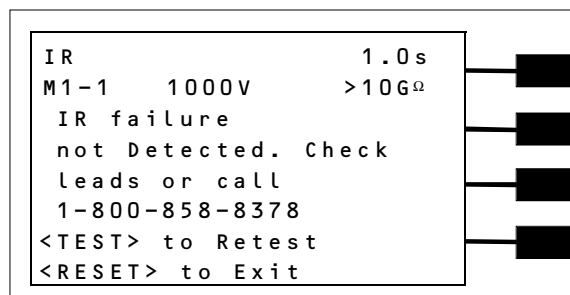

7. Connection of Remote I/O

Two 9-pin “D” type connectors are mounted on the rear panel that provide REMOTE-INPUT-OUTPUT control and information. These connectors mate with standard 9 pin D-sub-miniature connector provided by the user. The output mates to a male (plug) connector while the input mates to a female (receptacle) connector. For best performance, a shielded cable should be used. To avoid ground loops the shield should not be grounded at both ends of the cable. Suggested AMP part numbers for interconnecting to the Remote I/O are shown below:

205204-4	PLUG SHELL WITH GROUND INDENTS
205203-3	RECEPTACLE SHELL
745254-7	CRIMP SNAP-IN PIN CONTACT (for plug)
745253-7	CRIMP SNAP-IN SOCKET CONTACT (for receptacle)
745171-1	SHIELDED CABLE CLAMP (for either plug or receptacle)
747784-3	JACKSCREW SET (2)

Remote Interface Rear Panel:

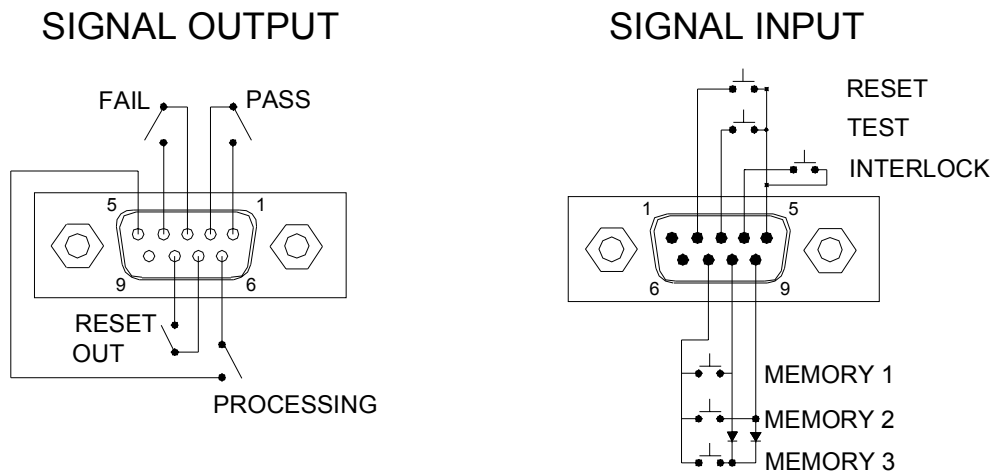

7.1. Signal Outputs on Remote I/O

The rear panel connector provides three output signals to remotely monitor PASS, FAIL, and PROCESSING conditions. The monitoring signals are provided by three normally open internal relays that toggle on and off to indicate the condition of the tester. These are normally open free contacts and will not provide any voltage or current. The ratings of the contacts are 1 AAC / 125 VAC (0.5 ADC / 30 VDC). The signal outputs are provided on the 9-pin female D connector. Below is a listing that indicates what conditions activate each pin. When a terminal becomes active the relay closes thereby allowing the external voltage to operate an external device.

Pins 1 and 2 provide the PASS signal.
Pins 3 and 4 provide the FAIL signal.
Pins 5 and 6 provide the PROCESSING signal.
Pins 7 and 8 provide the RESET OUT signal.

The following describes how the relays operate for each test condition:

PROCESSING - The relay contact closes the connection between pin (5) and pin (6) while the instrument is performing a test. The connection is opened at the end of the test.

PASS - The relay contact closes the connection between pin (1) and pin (2) after detecting that the item under test passed all tests. The connection is opened when the next test is initiated or the reset function is activated.

FAIL - The relay contact closes the connection between pin (3) and pin (4) after detecting that the item under test failed. The connection will open when the next test is initiated or the reset function activated.

RESET OUT - The relay contact closes the connection between pin (7) and pin (8) while the reset function is activated. This is only a continuous closure dependent on the length of time the reset button is held in an active state.

7.2. Signal Inputs of Remote I/O and Memory Access

The Hypot III remote connector enables remote operation of the TEST, RESET, and REMOTE INTERLOCK functions, and allows the operator to select Memory 1, Memory 2, and Memory 3.

When the PLC Remote mode is on, the Hypot III will respond to simple switch or relay contacts closures. A normally open momentary switch can be wired across pins 3 and 5 to allow remote operation of the TEST function. A normally open momentary switch can be wired across pins 2 and 5 to allow remote operation of the RESET function. When the PLC remote function is (ON) the TEST switch on the front panel will be disabled to prevent a test from being activated through this switch. For safety, the front panel RESET switch remains active even when a remote reset switch is connected so that high voltage can be shut down from either location.

The Hypot III also allow access to three MEMORY PROGRAMS through the remote control connector. This gives the user the capability to quickly change parameters and initiate a test remotely. The Hypot III basically operates in a PLC mode by responding to simple switch or relay contact closures. The built in memory programs of the instrument are used to accomplish this. Three internal memory programs can be accessed, by connecting terminals 7, 8, and 9 in different combinations.

WARNING

ACTIVATING MEMORY PROGRAM FUNCTIONS THROUGH THE REMOTE CONNECTOR, SELECTS THE PROGRAM AND STARTS THE TEST WHICH IS PREPROGRAMMED INTO THAT MEMORY

CAUTION

DO NOT CONNECT VOLTAGE OR CURRENT TO THE SIGNAL INPUTS, THIS COULD RESULT IN DAMAGE TO THE CONTROL CIRCUITRY.

MEMORY ONE - Momentarily connecting terminal 7 to 8 signals the instrument to immediately begin the test program that is stored in memory one.

MEMORY TWO - Momentarily connecting terminal 7 to 9 signals the instrument to immediately begin the test program that is stored in memory two.

MEMORY THREE - Momentarily connecting terminal 7 to terminals 8 and 9 signals the instrument to immediately begin the test program that is stored in memory three.

Remote Interlock

Hypot III is equipped with a feature referred to as “Remote Interlock”. Remote Interlock is a feature that utilizes a set of closed contacts to enable the instruments output. In other words, if the Interlock contacts open, the output of the instrument will be disabled. Remote Interlock could also be referred to as a remote system lockout, utilizing “Fail When Open” logic. If the Interlock contacts are open and the Test button is pushed, a pop-up message will be displayed on the screen for two seconds. The message will appear as follows:

Interlock is Open

If the Interlock contacts are opened during a test, the pop-up message will be displayed and the test will abort. The hardware has been configured to provide the interlock connections on pins 4 and 5 of the Remote Interface, Signal Input port. The instrument can still be used without the external interlock device as long as the Interlock Connector (38142 provided with unit) is plugged into the Remote Interface, Signal Input port. If there is nothing connected to the Remote Interface, Signal Input port to provide a connection to the interlock, the instrument will not perform tests.

PLC Remote Pop-up message

If you attempt to start a test from the front panel Test button and the PLC remote function is turned “ON”, a pop-up message will be displayed. The pop-up message will appear as follows:

PLC Remote ON

8. Options

Introduction

This section contains a list and descriptions of available factory installed options at the time of this printing. The list of options contains an option code number that can be referenced on the data plate on the rear panel of the unit.

Option Label

On the rear panel of the instrument, you will find a label that contains the option code.

For example, your options code would appear as follows:

Fitted with option 01 OPT: 01
 Fitted with option 01 and 02..... OPT: 0102

Hypot III Options

Option List

Code	Description
01	High Resolution IR Limits
02	5mA Output Current

Description

01 High Resolution IR Limits

The High Resolution IR Limits option, increases the resolution of the Max and Min trip point limits from 1M Ω to 0.1M Ω , in the range of 0.0 to 999.9M Ω .

The Max and Min Lmt set points automatically range while being edited according to the specification table below. This is unique only to this feature because this option has multiple ranges.

INSULATION RESISTANCE TEST MODE	
Maximum Limit	Range: 0.0 , 1.0 – 999.9 M Ω (0 = Off) Resolution 0.1 M Ω Range 1000 – 9999 M Ω Resolution 1 M Ω Accuracy Same as Resistance display
Minimum Limit	Range: 1.0 – 999.9 M Ω Resolution 0.1 M Ω Range 1000 – 9999 M Ω Resolution 1 M Ω Accuracy Same as Resistance display

02 5mA Output

The 5mA Output option limits the output current with software control. The trip points are adjusted to a maximum of 5mA and the software has been modified so the high-speed maximum current shutdown is fixed at 5mA. The following specifications have been changed for this option:

DIELECTRIC WITHSTAND TEST MODE		
Output Rating		5000V @ 5 mA AC 6000V @ 5 mA DC
Maximum Limit	AC	Range: 0.00 - 5.00 mA
	DC	Range: 0 - 5000 μ A
Minimum Limit	AC	Range: 0.000 - 0.500 mA
	DC	Range: 0.0 - 50.0 μ A

9. Calibration Procedure

This instrument has been fully calibrated at the factory in accordance to our published specifications. It has been calibrated with standards traceable to the National Institute Standards & Technology (NIST). You will find in this manual a copy of the "Certificate of Calibration". It is recommended that you have this instrument re-calibrated and a safety check done at least once per year. AR recommends you use "Calibration Standards" that are NIST traceable, or traceable to agencies recognized by NIST to keep this instrument within published specifications.

End user metrology standards or practices may vary. These metrology standards determine the measurement uncertainty ratio of the calibration standards being used. Calibration adjustments can only be made in the Calibration mode and calibration checks or verifications can only be made while operating in Test mode.

9.1. Warranty Requirements

AR offers a standard one-year manufacture's warranty. This warranty can be extended an additional four years provided that the instrument is returned each year to Associated Research, Inc. for its annual calibration. In order to be eligible for the extended warranty instruments must be returned to Associated Research, Inc. for calibration service at least once every twelve months.

A return material authorization number (RMA) must be obtained from AR before returning this instrument for calibration. To obtain an RMA number or for information regarding our warranty please contact our Customer Support Representatives at 800-858-TEST.

Required Calibration Equipment

- 0 - 5 KV AC/DC Metered Voltage Divider.
- 20 mA AC, 10 mA DC Ammeter.
- 0 - 30 mV AC Millivoltmeter.
- 10 Ω , 0.25 watt resistor, 250 volt.
- 50M Ω , 0.25 watt resistor, 1000 volt.
- 500M Ω , 0.25 watt resistor, 1000 volt.
- 100K Ω , 175 watt resistor, 4000 volt.
- 1M Ω , 20 watt resistor, 4000 volt.

9.2. Calibration Initialization

Press and hold the calibration key on the rear panel with a pen, pencil or small screwdriver while powering ON the Hypot III. The Hypot III enters calibration mode after the power on sequence is complete. The Calibration screens will appear as follows:

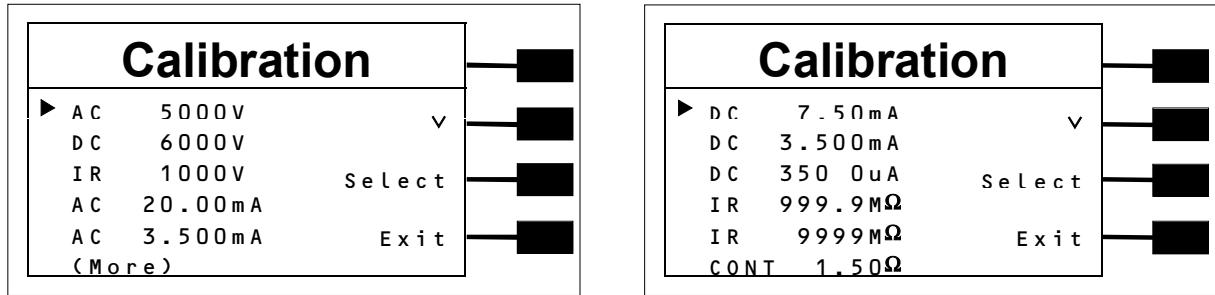

9.2.1. Calibration of Parameters

From the Calibration screens, use the “ \vee ” soft key to scroll the Cursor to the parameter you wish to calibrate. Once the cursor is pointing to the parameter you wish to calibrate, press the Select soft key. A calibration prompt screen will now appear that describes the necessary load and connection information for the parameter being calibrated.

The following is a list of the calibration parameters and an example of the prompt screen with the details that will be displayed for each parameter (screen shown at left). Once you press TEST, the Calibration data entry screen will appear for the selected parameter (screen shown at right). Adjust the numeric value of the parameter using the “+” and “-” soft keys and press the Enter soft key to accept the new parameter or press RESET to escape the edit.

Calibration of AC Hipot Voltage

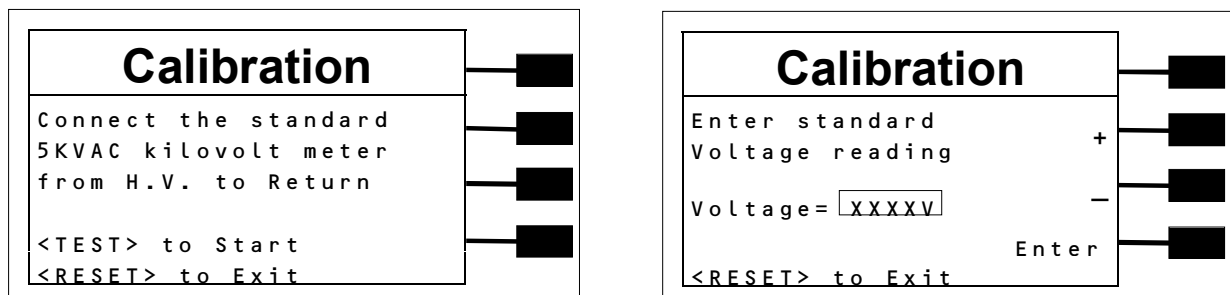

Calibration of DC Hipot Voltage

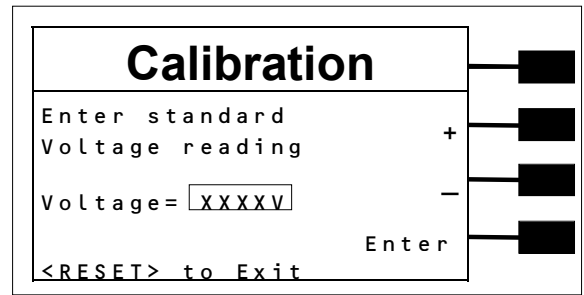
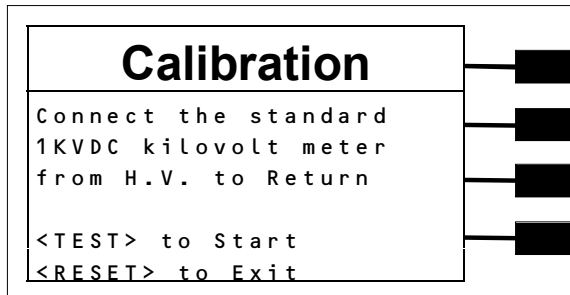

Calibration of IR DC Voltage

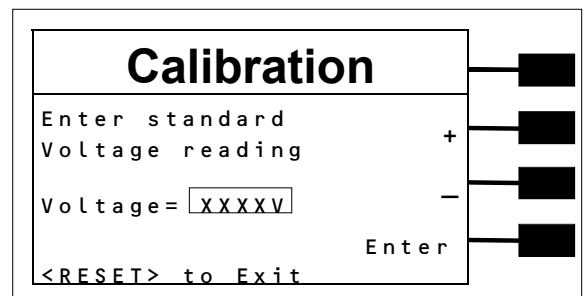
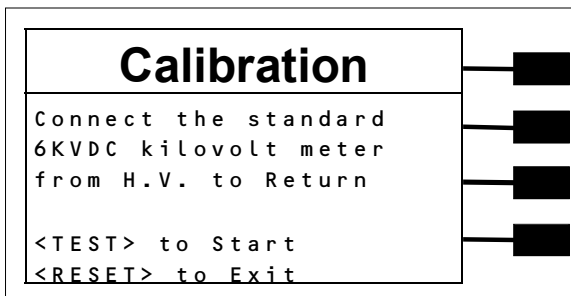

Calibration of AC Current 20.00mA range

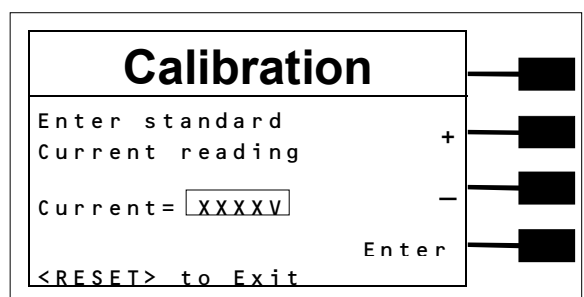
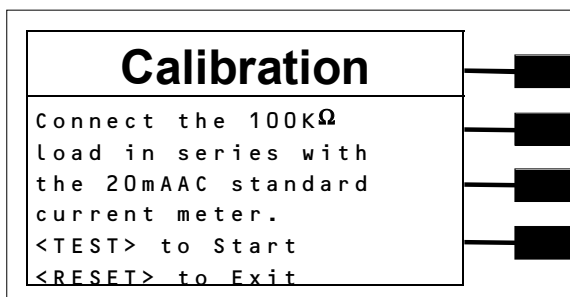

Calibration of AC Current 3.50mA range

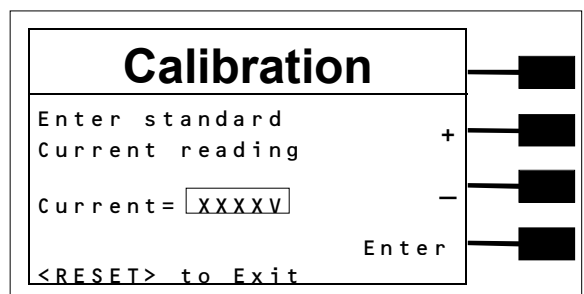
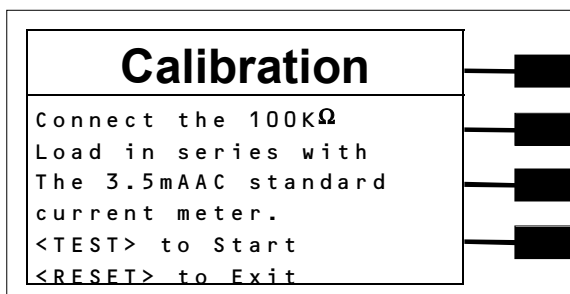

Calibration of DC Current 7.50mA range

Calibration

Connect the 100K Ω load in series with the 7.5mADC standard current meter.
 <TEST> to Start
 <RESET> to Exit

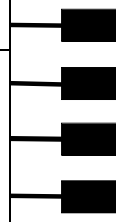

Calibration

Enter standard Current reading +
 Current = -
 Enter
 <RESET> to Exit

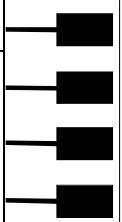

Calibration of DC Current 3.50mA range

Calibration

Connect the 100K Ω load in series with the 3.5mADC standard current meter.
 <TEST> to Start
 <RESET> to Exit

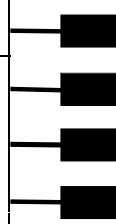

Calibration

Enter standard Current reading +
 Current = -
 Enter
 <RESET> to Exit

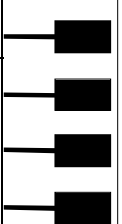

Calibration of DC Current 350 μ A range

Calibration

Connect the 1M Ω Load in series with the 350uADC standard current meter.
 <TEST> to Start
 <RESET> to Exit

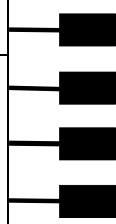

Calibration

Enter standard Current reading +
 Current = -
 Enter
 <RESET> to Exit

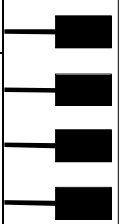

Calibration of IR 999.9M Ω and 9999M Ω Ranges

Calibration

Connect the standard 50M Ω load from H.V. to Return.
 <TEST> to Start
 <RESET> to Exit

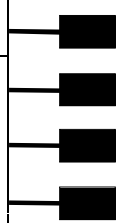

Calibration

Automatic
 calibration
 processing...

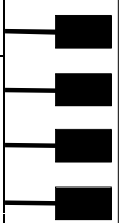

Calibration of Continuity, Step 1

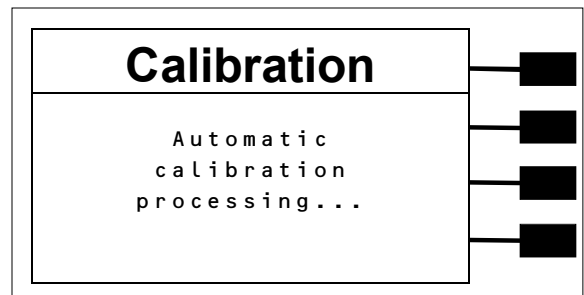
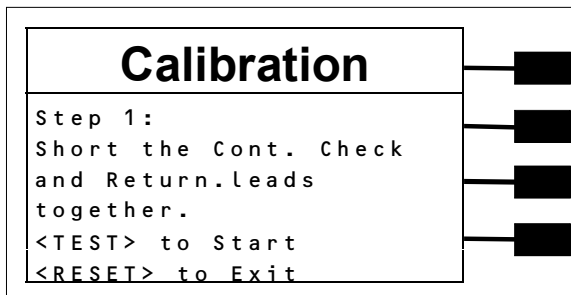

Calibration of Continuity, Step 2

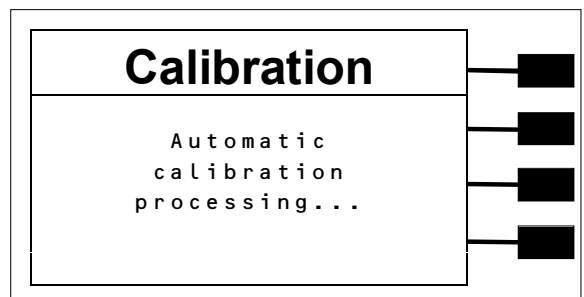
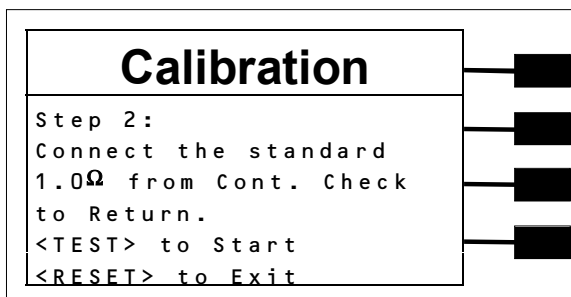

10. Replacement Parts List

ECO: 4873 Rev.C

Part Number	Qty.	Reference Designator	Description
35999	4	-	Black Banana Jacks
37497	1	-	Reset Switch, Red
37555	1	-	Power Switch 2P 10A/250V
37571	1	-	Earth Connector
37605	2	Fail, Ready	Bulbs
37673	1	-	Switch Test, Green
37783	1	RY1	Relay Gunther 3390-1290-246
37784	1	RY2	Relay Gunther 3392-1290-246
38075	1	-	Interlock Connector
38101	1	-	Feet Kit w/o Rubber Inserts
38102	4	-	Rubber Insert for Feet
38202	1		Adapter Box
38262	1	IC16	Microcontroller 78E516B PLCC
38367	1	CON 3670	Main Control Board
38264	1	HV 3670	High Voltage Board
38265	1	HRY 3670	HV Relay Board
38266	1	AMP 3670	Power Amplifier Board
38267	1	KEY 3670	Keypad Board
38268	1	PWR 3670	Input Voltage Select PCB
38271	1	-	High Voltage Connector w/10cm cable
38272	1	-	High Voltage Connector w/10cm cable
38287	1	T1	Input Transformer
38288	1	T2	Output High Voltage Transformer
38320	1	-	128 x 64 Graphic Display
04040A-08	1	-	High Voltage Output cable
02100A-13	2	-	Return cable

- For safety tester interconnect cables, refer to INSTRUMENT CONNECTIONS; section 1.3 Specific Integrated System Connections

11. Schematic Index

Drawing Number	Description	Reference Designator	Pages
S03605	Wiring Diagram 3605	-	1
S03670	Wiring Diagram 3665, 3670	-	1
S38367	Main Control Board	CON 3670	3
S38264	High Voltage Board	HV 3670	1
S38265	HV Relay Board 3665, 3670	HRY 3670	1
S38266	Power Amplifier Board	AMP 3670	2
S38267	Keypad Board	KEY 3670	1
S38268	Input Voltage Select PCB	PWR 3670	1

12. Index

AC Withstand.....	27, 36, 39, 42, 46
Adapter Box.....	17, 24, 43
Alarm Parameter	31
Arc.....	14, 20, 38, 39, 40, 42, 47
Benefits.....	14
Breakdown.....	3, 47
Calibration Alert	
Alert Date.....	33, 34
Cal Alert.....	29, 33
Cal Date	29, 33
Cal Due	29, 33
Date.....	29, 33, 34
Time.....	29, 34
Calibration Procedure.....	60
Connected Steps.....	17, 30, 31, 44, 46, 61
Continuity Test.....	11, 15, 24, 39, 40
Contrast.....	23, 29, 31, 42
Controls	14, 20, 24, 25, 29, 44, 45
DC Withstand.....	36, 40, 41, 42, 46, 47
Default Parameters	27, 42
Delay.....	22, 38, 41, 42, 47
Dielectric Withstand Test	8, 9, 42, 44, 46
Discharge	7, 10, 11, 21
DUT.....	6, 7, 12, 13, 14, 16, 27, 28, 39, 40, 43, 46, 47
Dwell	15, 21, 38, 39, 40, 42, 47
Edit Parameters	34, 36, 37, 39, 40, 41, 42, 61
Features.....	8, 14
Frequency	9, 15, 20, 21, 38, 39, 40, 42
Front Panel Controls.....	14, 24
Glossary	3
Hypot.....	3
Insulation Resistance.....	3, 8, 11, 13, 41, 47
Interlock.....	15, 23, 25, 27, 56
LCD.....	14, 24, 31, 46
Leakage.....	3, 6, 10, 11, 12, 13, 14, 15, 19, 33
Limits.....	37, 38, 42, 47, 58

Lockout.....	20, 27, 56
Max Lmt	37, 42, 47
Medical Restrictions.....	6
Memory	15, 23, 25, 27, 32, 36, 38, 39, 40, 41, 44, 45, 46, 55, 56
Menu.....	12, 14, 26, 29, 32, 36, 37, 43, 44, 45, 46, 49
Min Lmt	38, 42, 47, 58
Operator.....	5, 6, 10, 14, 15, 18, 24, 26, 33, 55
Options.....	34, 58
Parameters	
System Parameters	27, 29, 30, 45
Test Parameters	14, 23, 36, 37, 42, 44, 45
PLC.....	15, 29, 30, 42, 55, 57
Programming.....	29
Ramping.....	16, 47
Rear Panel Controls.....	25
Receptacle.....	16, 18, 23, 25, 26, 54
Regulation.....	14, 21
Remote.....	6, 15, 23, 25, 27, 29, 30, 42, 47, 49, 54, 55, 56, 57
Remote Interlock.....	23, 27, 56
Resistance	3, 5, 6, 8, 11, 12, 13, 22, 37, 38, 39, 40, 41, 46, 47, 58
Reviewing Test Results	28, 32, 37
Safety.....	2, 4, 7, 8, 18, 23, 26
Safety Symbols	2
Schematic.....	66
Schematic Index.....	66
Security.....	14, 23, 32, 35
Sequence.....	17, 30, 31, 46, 61
Service Interval	4
Setup.....	14, 29, 30, 42, 45, 46
Short	22, 27, 39, 40, 47
Single Step.....	29, 30, 42, 44, 46
Smart GFI	23, 27, 29, 32, 33, 42
Specifications.....	20
Test Station	5, 7
Trip Point.....	3, 37, 38, 39, 40, 41, 42, 47, 58
TUV.....	14
UL.....	8, 12, 14, 15, 49
Unpacking.....	17
Verification.....	26, 49, 50, 51, 52, 53

Warranty1, 4, 60